

amaran[®]

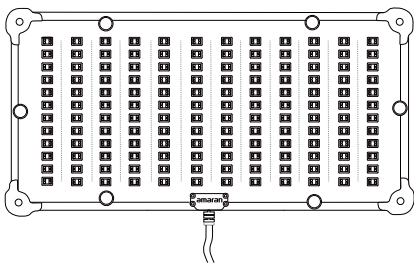

amaran F21x

Product Manual

English

Foreword

Thank you for purchasing "amaran" LED photography lights - amaran F21x.

Amaran F21x is amaran newly designed cost performance light fixture. Compact structure design, compact and light, excellent texture.

Has a high performance level, such as high brightness, high color rendering index, can adjust the brightness, etc. It can be used with variety of lighting accessories to achieve lighting effects and enrich product usage patterns. So that the product to meet the needs of different occasions light control, easy to achieve professional level photography.

IMPORTANT SAFETY INSTRUCTIONS

When using this unit, basic safety precautions should always be followed, including the following:

1. Read and understand all instructions before using.
2. Close supervision is necessary when any fixture is used by or near children. Do not leave the fixture unattended while in use.
3. Care must be taken as burns can occur from touching hot surfaces.
4. Do not operate the fixture if a cord is damaged, or if the fixture has been dropped or damaged, until it has been examined by qualified service personnel.
5. Position any power cables such that they will not be tripped over, pulled, or put into contact with hot surfaces.
6. If an extension cord is necessary, a cord with an amperage rating at least equal to that of the fixture should be used. Cords rated for less amperage than the fixture may overheat.
7. Always unplug the lighting fixture from the electrical outlet before cleaning and servicing, or when not in use. Never yank the cord to remove the plug from the outlet.

8. Let the lighting fixture cool completely before storing. Unplug the power cable from lighting fixture before storing and store the cable at assigned space of the carrying case.

9. To reduce the risk of electric shock, do not immerse this fixture in water or any other liquids.

10. To reduce the risk of fire or electric shock, do not disassemble this fixture. Contact cs@aputure.com or take the lighting fixture to qualified service personnel when service or repair is required. Incorrect reassembly may cause electric shock when the lighting fixture is in use.

11. The use of any accessory attachment not recommended by the manufacturer may increase the risk of fire, electric shock, or injury to any persons operating the fixture.

12. Please power this fixture by connecting it to a grounded outlet.

13. Please do not block the ventilation or do not look at the LED light source directly when it is powered on.

Please do not touch the LED light source in any condition.



14. Please do not place the LED lighting fixture near any flammable object.

15. Only use a dry microfiber cloth to clean the product.

16. Please do not use the light fixture in wet condition on account of electric shock may be caused.

17. Please have the product checked by an authorized service personnel agent if the product has a problem. Any malfunctions caused by unauthorized disassembly are not covered by the warranty. The user may pay for maintenance.

18. We recommend only using the original Aputure cable accessories. Please note that any malfunctions caused by using unauthorized accessories are not covered by the warranty. The user may pay for maintenance.

19. This product is certified by RoHS, CE, KC, PSE, and FCC. Please operate the product in full compliance with relevant country's standards. Any malfunctions caused by incorrect use are not covered by warranty. The user may pay for maintenance.

20. The instructions and information in this manual are based on thorough, controlled company testing procedures. Further notice will not be given if the design or specifications change.

SAVE THESE INSTRUCTIONS

FCC Compliance Statement

This device complies with Part 15 of the FCC Rules. Operation is subject to the following two conditions:

- (1) This device may not cause harmful interference.
- (2) This device must accept any interference received, including interference that may cause undesired operation.

Warning: Changes or modifications not expressly approved by the party responsible for compliance could void the user's authority to operate the equipment.

NOTE: This equipment has been tested and found to comply with the limits for a Class B digital device, pursuant to Part 15 of the FCC Rules. These limits are designed to provide reasonable protection against harmful interference in a residential installation. This equipment generates, uses, and can radiate radio frequency energy and, if not installed and used in accordance with the instructions, may cause harmful interference to radio communications. However, there is no guarantee that interference will not occur in a particular installation. If this equipment does cause harmful interference to radio or television reception, which can be determined by turning the equipment off and on, the user is encouraged to try reorient or relocate the receiving antenna. Increase the separation between the equipment and receiver. Connect the equipment to an outlet on a different circuit than the receiver is connected to. Consult the dealer or an experienced radio/TV technician for help. This device has been evaluated to meet general RF exposure requirements.

Components List

Please make sure all accessories listed below are completed before using. If not, please contact with your sellers immediately.

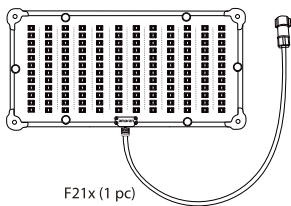

F21x (1 pc)



Control Box (1 pc)

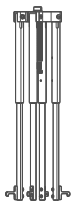

Frame (1 pc)

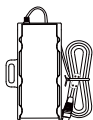

Power Adapter (1 pc)
(*Anton Bauer or
V-mount)



Extension Cable (1 pc)



AC Cable (1 pc)

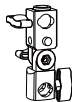

Tie Down (1 pc)



Soft Box (1 pc)

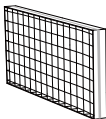

45°Grid (1 pc)



Fabric Diffusion 1 (1 pc)
Fabric Diffusion 2 (1 pc)



Carry Case (1 pc)

Tips: The illustrations in the manual are only diagrams for reference. Due to the continuous development of new versions of the product, if there are any differences between the product and the user manual diagrams, please refer to the product itself.

Components List

1. Lamp Head

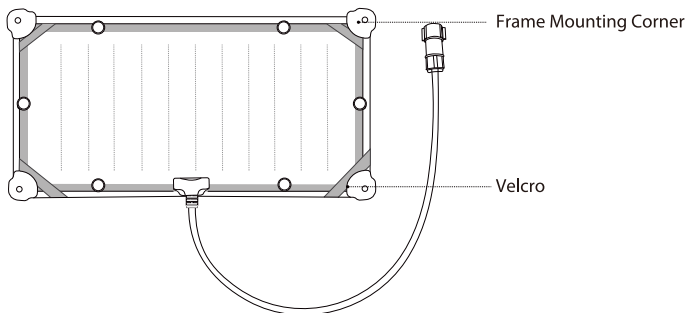
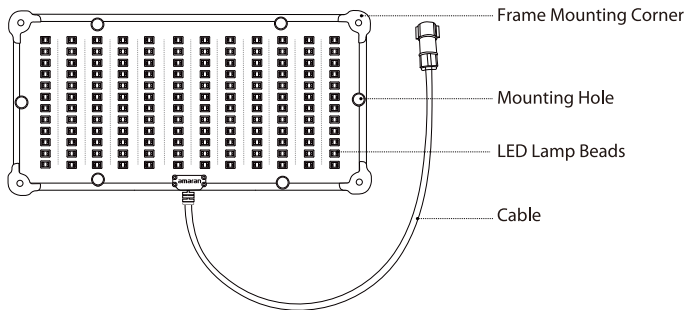

2. Control Box

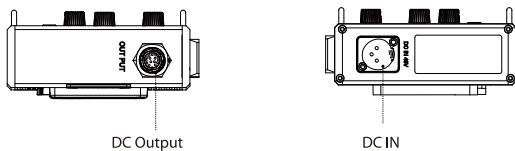
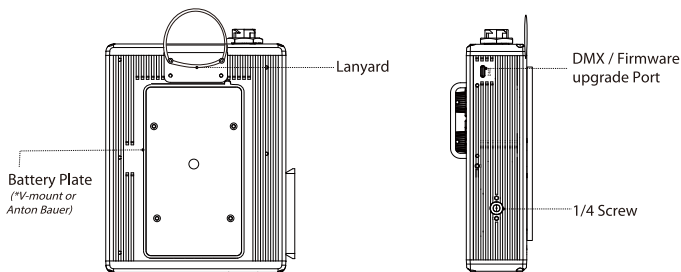
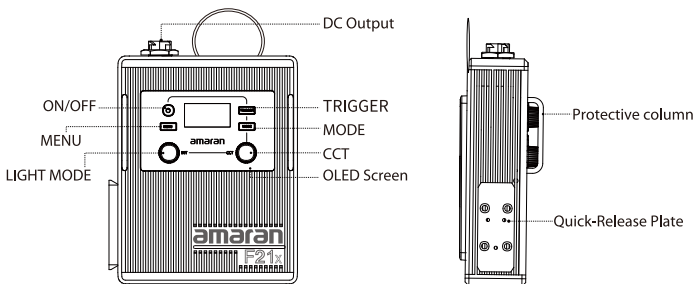

Installation

1. Assembly and disassembly of the X-shaped support frame:

Installation: Apply inward force to insert the support rods into the slots. Repeat the process for all support rods.

Disassembly: Pull the support rods outward to remove them from the slots. Repeat the process for all support rods. Use Velcro straps to secure and store the support rods.

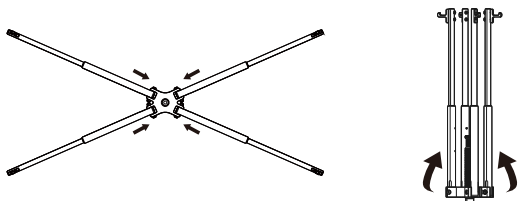

2. Assembly and disassembly of the lamp body and X-shaped frame:

Installation: Place each of the four support rods into the corner brackets of the lamp body, applying inward force.

Disassembly: Apply inward force to remove the support rods from the corner brackets.

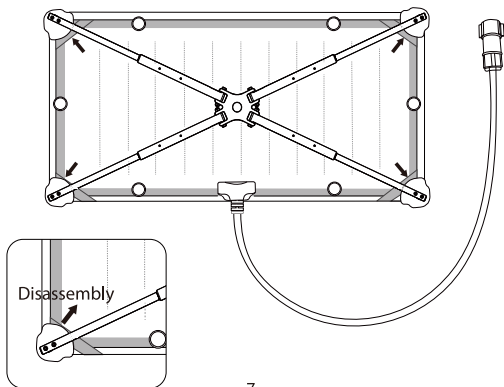

3. Installation of soft box.

The side of the soft box with grooves corresponds to the side of the lamp body with the power cord. Then attach the velcro of the lamp body and the soft box in turn and then install the fabric diffusion and grid.

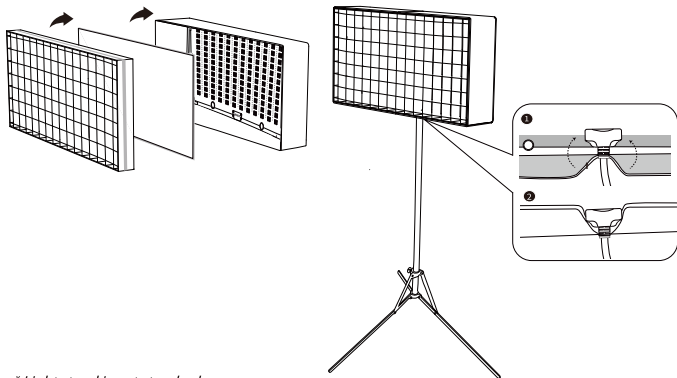

** Light stand is not standard.*

4. Fasten the lamp body.

Adjust the lamp body to a suitable height, rotate the tightening handle to fix the lamp body on the tripod, and then adjust the lamp body to the required angle, Then tighten the locking handle.

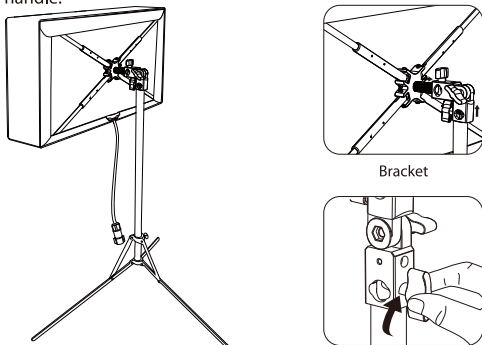

Powering up the Light

Powered by AC

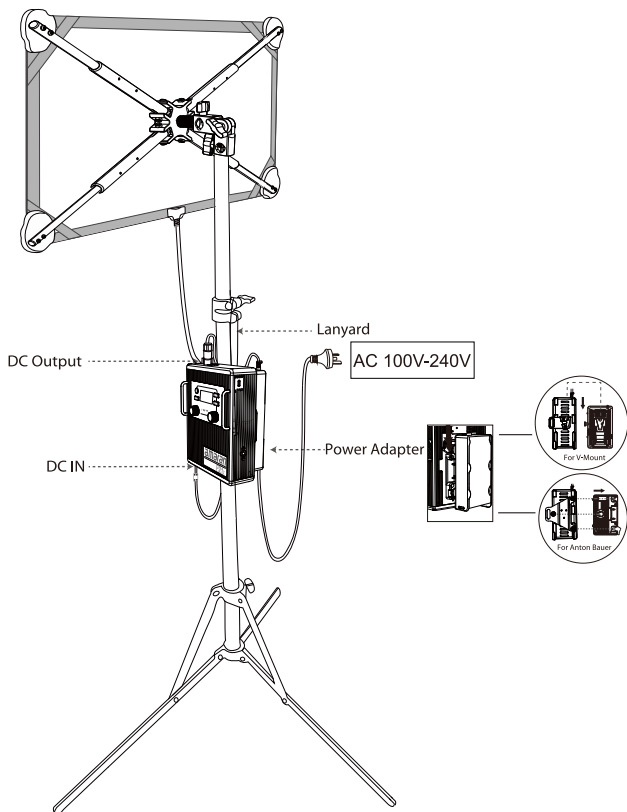

Powered by DC

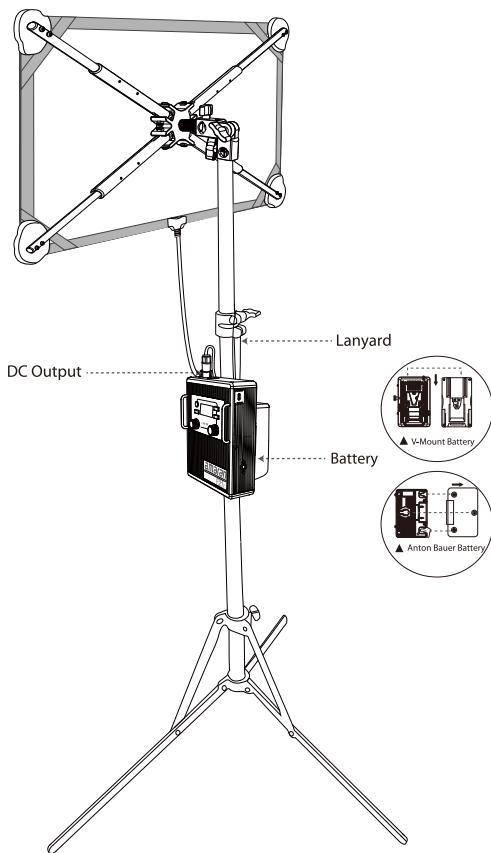

How to use the extension cord

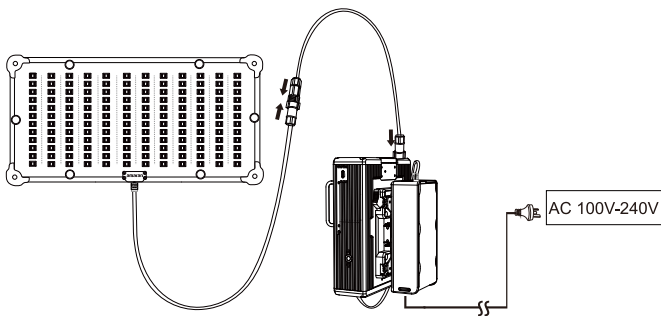

**The battery is not standard.*

**When removing the wire, because of self-locking device at the wire connection, please press or rotate the spring lock on the connector before pulling it out. Do not pull it out forcibly.*

**Extension cable, control box and lamp body need to correspond, and different models cannot be mixed.*

Operations

1. Turning on the Light

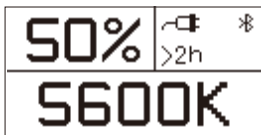
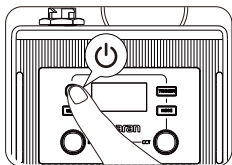

2. Manual Control

2.1 Press the Light Mode button to enter the interface



2.2.1 Press the INT knob, select CCT mode to adjust color temperature (2500K~7500K), brightness (0%~100%) .

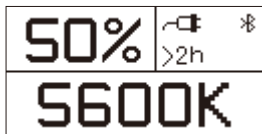

2.2.2 Press the INT button to select FX mode, then rotate the INT control knob to toggle between Paparazzi , Lightning , TV ,Fire, Strobe,Explosion,Fault Bulb, Pulsing , Fireworks.



**Under Lightning and Explosion effects, press the TRIGGER knob, will trigger the effects ; under other effects press the INT TRIGGER to circulate or stop the effects.*

2.2.3 Press the INT knob, after selecting the CFX mode, Rotate the INT knob to select the Picker FX, Music FX, and TouchBar FX.

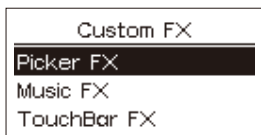

2.3 Press the MENU button to enter MENU, as shown in the figure below.

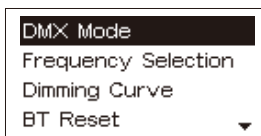

2.3.1 DMX Mode

Press the INT knob to enter the DMX mode, and rotate the INT knob to adjust the DMX channel (001~512).

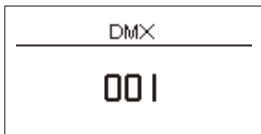

2.3.2 Frequency Selection

Press the INT knob to enter the Frequency Selection, Rotate the INT knob to select the frequency (+0~2000Hz).

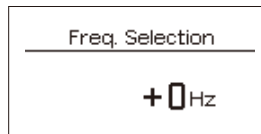

2.3.3 Dimming Curve

Press the INT knob to enter the dimming curve menu, rotate the INT knob to select "Exp; Log; S-curve; Linear" Dimming curve, then press the INT knob to confirm the selection.

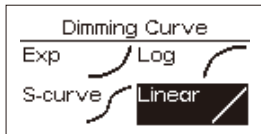

2.3.4 BT Reset

Press the INT knob to enter the BT Reset, rotate the INT knob to select "Yes", press the INT knob to reset the Bluetooth; select "No" to return to the main menu.

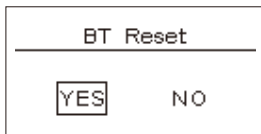

2.3.5 BT Serial NO.

Rotate the INT knob to select the BT serial NO, press the INT knob to enter the BT serial NO. interface to display the Bluetooth serial number

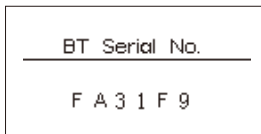

2.3.6 Studio Mode

Rotate the INT knob to select the studio mode, press the INT knob to enter the studio mode interface, rotate the INT knob to select "Yes" or "No", and then short press the INT knob to confirm.

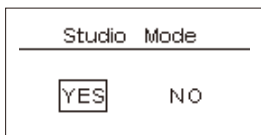

2.3.7 Language

Rotate the INT knob to select the language menu, press the INT knob to enter the language setting interface, rotate the INT knob to select "English" or "Chinese", and then press the INT knob to confirm.

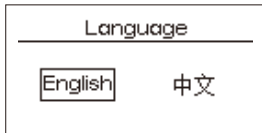

2.3.8 Firmware Version

Rotate the INT knob to select the Firmware Version, press the INT knob to enter the firmware version interface, short press the INT knob again to return to the main menu.

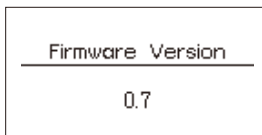

2.3.9 Update Firmware

Rotate the INT knob to select Update Firmware, short press the INT knob to enter the firmware upgrade interface, rotate the INT knob to select "Yes" or "No", and then press the INT knob to confirm.

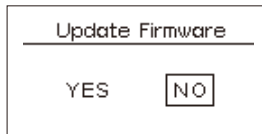

2.3.10 Factory Reset

Rotate the INT knob to select Factory Reset, press the INT knob to enter the Factory Reset interface, rotate the INT knob to select "Yes" or "No", and then press the INT knob to confirm.

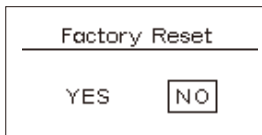

3. DMX Control

3.1 Connecting Type-c to DMX adapter to controller

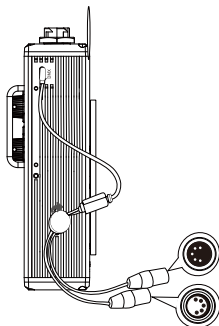

**Type-c to DMX adapter is not standard*

3.2 Connect a standard DMX controller

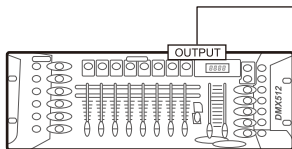

DMX512

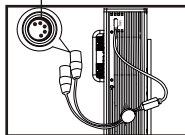

Connecting DMX to only one light

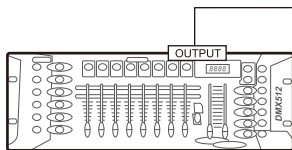

DMX512

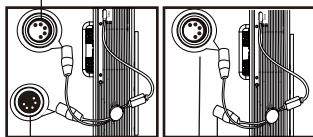

Daisy chaining multiple lights using DMX

3.3 The DMX interface schematic:

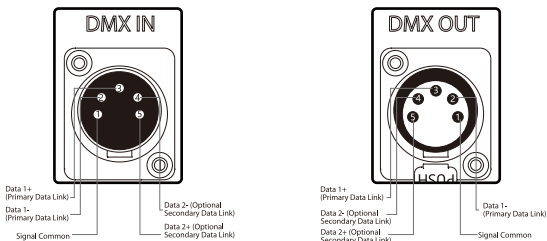

3.4 DMX Channel Selection

In DMX mode, match the channel of your DMX controller with the light, and then control the light via DMX controller.

4. Using the Sidus Link APP

You can download the Sidus Link app from the iOS App Store or Google Play Store for enhancing the functionality of the light. Please visit sidus.link/app/help for more details regarding how to use the app to control your Aputure lights.



Get Sidus Link[®] App



[Sidus.link/app/help](https://sidus.link/app/help)

5. Specifications

CCT	2500K~7500K	CRI	≥95
TLCI	≥98	Power Output	100W (Max)
Power Input	120W (Max)	Operating Current	2.5A (Max)
Power Supply	48V	Operating Temperature	-10°C ~ 40°C
Voltage	V-Mount battery	12 ~ 28.8V	
	V-mount battery compatibility	16.8V ,26V, 28.8V battery full output.	
	Power adapter output	48V	
Controlling method	Manual, Sidus Link APP, DMX		
Remote control distance (Bluetooth)	≤ 80m / 262.5ft, 2.4G Hz		
Display	OLED		
Cooling Mode	Light fixture	Natural heat dissipation	
	Controller	Natural heat dissipation	

Photometrics

CCT	Distance (m)			
	Illuminance (lux)	0.5m	1m	3m
2500K	Bare Bulb	9580	3130	342
	Softbox (1/2 stop)	5530	1678	222
3200K	Bare Bulb	10510	3208	376
	Softbox (1/2 stop)	6160	1833	240
4300K	Bare Bulb	11120	3456	391
	Softbox (1/2 stop)	6390	1873	246
5600K	Bare Bulb	11200	3632	400
	Softbox (1/2 stop)	6590	1944	263

6500K	Bare Bulb	12170	3670	435
	Softbox (1/2 stop)	7060	2116	279
7500K	Bare Bulb	13470	3960	454
	Softbox (1/2 stop)	7170	2216	297

** These are average data measured in the laboratory, there will be slight differences in the brightness, color temperature and other parameters of different lights.*

Trademarks

Bowens is a trademark registered by Bowens in China and other countries.

You can find a detailed user guide for this device on our website www.aputure.com.