

amaran

amaran P60c

Product Manual

English

Foreword

Thank you for purchasing the amaran series LED photography light-amaran P60c.

The amaran P60c is a RGBWW full-color adjustable panel photography light with adjustable temperature (2500 K - 7500 K), power of 60w, and maximum illuminance of 5900 lux@1 m (5600 K). The P60c is also excellent in terms of light quality, with a color rendering index of up to CRI 95+, TLCI 97, G/M adjustable and no flicker at all.

The amaran P60 series is creators' best choice because of its feature of lightweight and flexibility.

IMPORTANT SAFETY INSTRUCTIONS

When using this unit, basic safety precautions should always be followed, including the following:

1. Read and understand all instructions before using.
2. Close supervision is necessary when any fixture is used by or near children. Do not leave the fixture unattended while in use.
3. Care must be taken as burns can occur from touching hot surfaces.
4. Do not operate the fixture if a cord is damaged, or if the fixture has been dropped or damaged, until it has been examined by qualified service personnel.
5. Position any power cables such that they will not be tripped over, pulled, or put into contact with hot surfaces.
6. If an extension cord is necessary, a cord with an amperage rating at least equal to that of the fixture should be used. Cords rated for less amperage than the fixture may overheat.
7. Always unplug the lighting fixture from the electrical outlet before cleaning and servicing, or when not in use. Never yank the cord to remove the plug from the outlet.
8. Let the lighting fixture cool completely before storing.
9. To reduce the risk of electric shock, do not immerse this fixture in water or any other liquids.
10. To reduce the risk of re or electric shock, do not disassemble this fixture. Contact cs@aputure.com or take it to qualified service personnel when service or repair work is required. Incorrect reassembly may cause electric shock when the lighting fixture is in use.

11. The use of an accessory attachment not recommended by the manufacturer may increase the risk of re, electric shock, or injury to any persons operating the fixture.
12. Power this fixture by connecting it to a grounded outlet.
13. Please do not place the LED lighting fixture near any flammable object.
14. Only use a dry microfiber cloth to clean the product.
15. Please have the product checked by an authorized service personnel agent if your product has a problem.
16. The malfunctions caused by unauthorized disassembly are not covered under the warranty.
17. We recommend only using the original Aputure cable accessories. Please note that our warranty for this product does not apply to any repairs required due to any malfunctions of unauthorized Aputure accessories, although you may request such repairs for a fee.
18. This product is certified by RoHS, CE, KC, PSE, and FCC. Please operate the product in full compliance with the operation standards. Please note that this warranty does not apply to repairs arising from malfunctions, although you may request such repairs on a chargeable basis.
19. The instructions and information in this manual are based on thorough, controlled company testing procedures. Further notice will not be given if the design or specifications change.

SAVE THESE INSTRUCTIONS

FCC compliance statement

This device complies with Part 15 of the FCC rules. The operating equipment must meet the following two conditions:

- (1) This device will not cause harmful interference;
- (2) This device can withstand any external interference, including interference that may cause unintended operation.

[Warning] If the user makes changes or modifications without the express permission of Aitus, he may lose the right to continue to operate the device.

[Note] This device has been tested and determined to comply with the limits of a Class B digital device (in accordance with Part 15 of the FCC rules).

These limits are designed to provide reasonable protection from harmful interference in residential installations. This device generates, uses, and can radiate radio frequency energy. If it is not installed and used in accordance with the instructions, it may cause harmful interference to radio communications. However, under certain installation conditions, there is no guarantee that such interference will not occur. If this equipment does cause harmful interference to radio or television reception, and this can be determined by turning off and on the equipment, it is recommended that the user try one or more of the following measures to eliminate the interference:

- Increase the distance between the equipment and the receiver.
- Connect the equipment to an outlet on another circuit, not the outlet on the circuit to which the receiver is connected.
- Consult the dealer or an experienced radio/TV technician for help

FCC radiation exposure statement

This device complies with FCC radiation exposure limits for uncontrolled environments.

Componets List

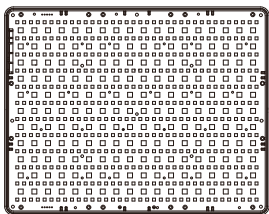

amaran P60c

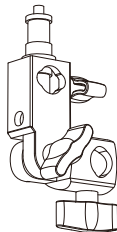

1/4 - 20 in & 3/8 - 16 in
Spigot

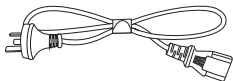

AC Power cable

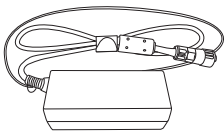

Adapter

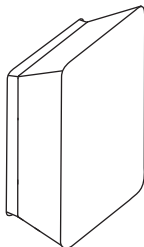

Softbox



Carrying case

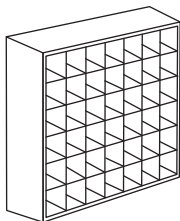

Grid

Product Details

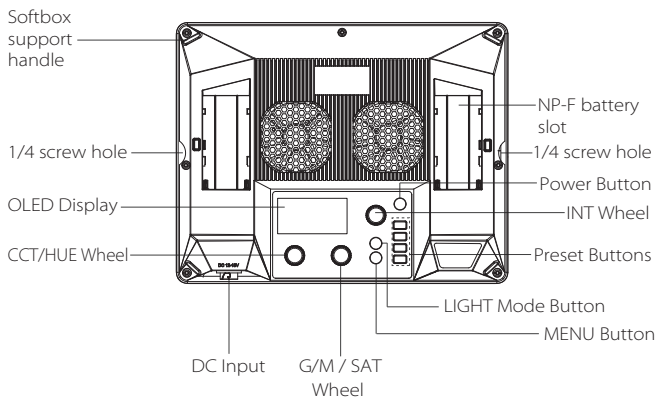
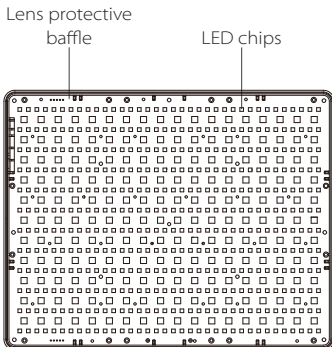

Installation

1. The lamp fixing

Screw the 1/4" to 3/8" screw clockwise into the 1/4" copper nut at the bottom (or side) of the LED lamp, and tighten it; Connect the 1/4" to 3/8" screw and the lamp holder through the lamp holder support column, adjust the appropriate angle and tighten it.

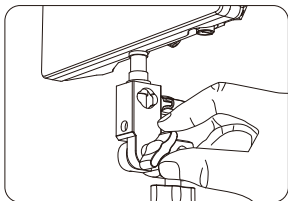
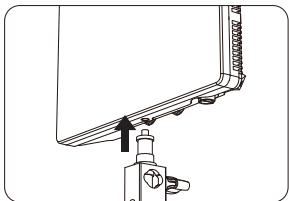

2. Softbox installation

The light soft box can be installed according to the needs of use.

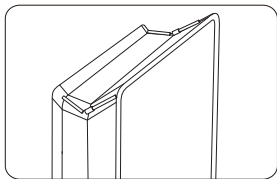

1. Stretch soft box

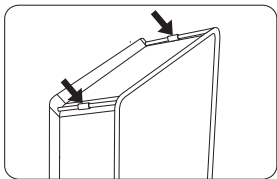

2. Straighten the two support rodson both sides of the soft box to become a support rod

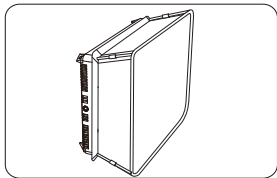

3. Install the soft box to the lamp body

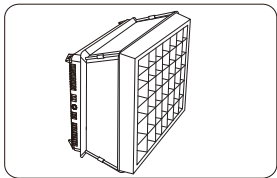

4. The grid can be installed according to the requirements

Power supply

1. Adapter power supply

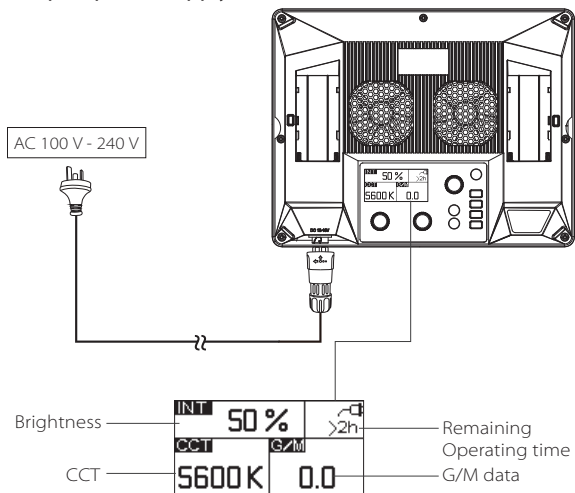

When disassembling the power cable, please rotate the spring lock button on the power cable before disassembling, do not pull it hard.

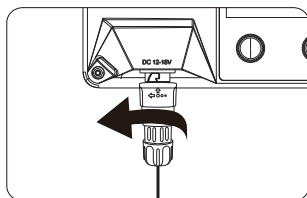

2. Lithium battery power supply

* This product uses a lithium battery model Sony NP-F Series: NP - F 960 / F 970.

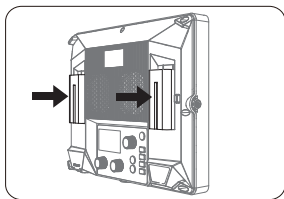

Battery Installation: Slide the lithium battery into the battery slot.

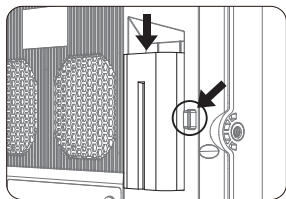

Press the battery lock button while gently pushing the battery to remove the battery.

3. V-mount battery or Anton Bauer battery power supply

Through the "D-tap to DC" connection cable, the lamp body can be connected to the V-mount battery or Anton Bauer battery for power supply.

* D-tap to DC cable needs to be purchased separately.

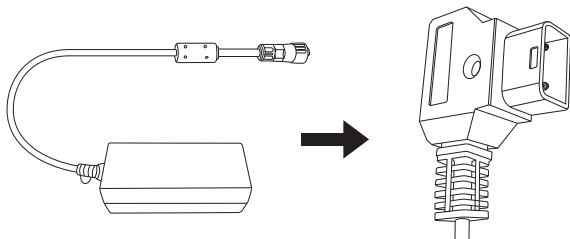

Operation Instructions

1. Turning on the Light

After connecting the lamp body to an appropriate power source, press the power switch to start the P60c.

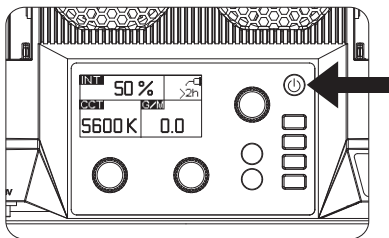

2. Manual Control

* The speed at which you rotate the knob will result in different rates of change.

Rotate the Intensity (INT) Wheel to adjust the intensity of the light from 0-100%.



Rotate the CCT / HUE wheel to adjust the CCT of the light from 2500K-7500K.



Rotate the Green-Magenta / Saturation (G/M / SAT) Wheel to adjust the the Green-Magenta Shift or Saturation output of the light fixture.

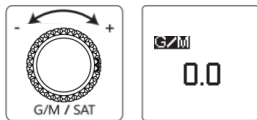

2.2 Light Mode Interface



2.2.1 Press the INT wheel to select CCT mode to adjust the color temperature of the light from 2500 K - 7500 K.

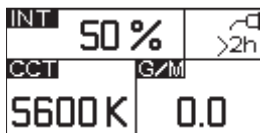

2.2.2 Press the Light Mode button to enter the main interface, press the INT wheel to select HSI mode to adjust the change of the HUE from 1° - 360°. SAT from 0% -100%.

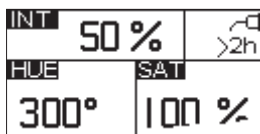

2.2.3 Press the Light Mode button to enter the main interface, press the INT wheel to select FX mode, then rotate the INT wheel to toggle between Lightning, Paparazzi, Strobe, Cop Car, Fireworks, Pulsing, Fault Bulb, Fire, TV, Party Lights,.



Lightning



Paparazz



Strobe

Strobe	INT	50%	
CCT	SPD	05	
HSI			
GEL			

Cop car

Cop Car	INT	50.0%	
R+B+W	FRQ	05	
R			
B			

Fireworks

Fireworks	INT	50%	
CCT	FRQ	05	
HUE			
CCT+HUE			

Pulsing

Pulsing	INT	50%	
CCT	FRQ	SPD	05
HSI			
GEL			

Faulty Bulb

Faulty Bulb	INT	50%	
CCT	FRQ	SPD	05
HSI			
GEL			

Fire



Fire	INT	50.0%	
Warmer	SPD	05	
Natural			
Cooler			

TV

TV	INT	50.0%	
Warmer	SPD	05	
Natural			
Cooler			

Party lights

Party Lights	INT	50.0%	
SAT	SPD	05	
100%			

2.24 Short press the INT wheel to enter or exit the light effect cycle, the icon is () in the cycle state, and the icon is () when the light effect is in the stop state; short press the INT wheel in the lightning mode (Lightning) to start a single Second trigger function, long press the INT wheel to perform cycle function ().

2.25 Short press INT to select the GEL mode, turn the INT wheel to adjust the brightness, turn the color temperature wheel to select 3200 K / 5600 K, and turn the G/M wheel to select the color paper model, and the light will be emitted synchronously corresponding to the filter paper effect.

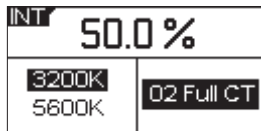

2.3 Press the MENU button to enter the menu interface.

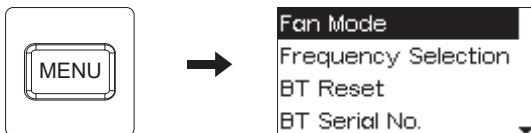

3. Menu introduction

3.1 Fan Mode

Press the MENU button to enter the menu interface, rotate the INT wheel to select and press to enter the Fan mode, rotate the INT wheel to select the smart/medium mode, and then short press the INT wheel to confirm the selection.



3.2 Freq. Selection

Press the MENU button to enter the menu interface, rotate the INT wheel to select and press to enter the Frequency Selection interface. Rotate the INT wheel to adjust the light frequency by 100Hz every turn.

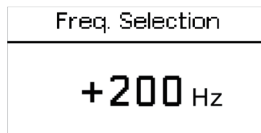

3.3 BT Reset

Press the MENU button to enter the menu interface, rotate the INT wheel to select and press to enter the Bluetooth Reset. Rotate the INT wheel to select "YES" to reset the Bluetooth pairing; if you choose "NO", then it will return to the previous menu.

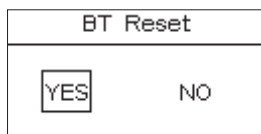

3.4 BT Serial No.

Press the MENU button to enter the menu interface, rotate the INT wheel to select and press to enter the Fixture Serial No. and you can see that device has a unique serial number.

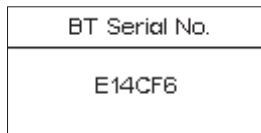

3.5 Studio Mode

Press the MENU button to enter the menu interface, rotate the INT wheel to select and press to enter the Studio mode interface. Rotate the INT wheel to select "Yes", and the power-on light is on.

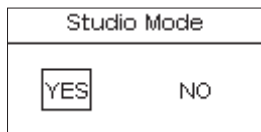

3.6 Language

Press the MENU button to enter the menu interface, rotate the INT wheel to select and press to enter the Language menu. You can rotate the INT wheel to select English or Chinese, and then press the Select wheel to confirm the selection.

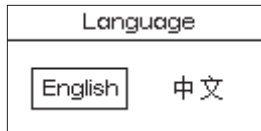

3.7 Firmware Version

Press the MENU button to enter the menu interface, rotate the INT wheel to select and press to enter the Firmware Version, You can check the firmware version number of the fixture.

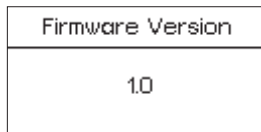

3.8 Factory Reset

Press the MENU button to enter the menu interface, rotate the INT wheel to select and press to enter Press the MENU button to enter the Factory Reset interface You can rotate the INT wheel to select "YES" . back to the factory settings.

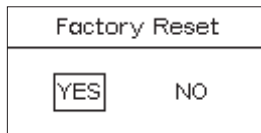

3.9 Custom FX

Press the MENU button to enter the menu interface, rotate the INT wheel to select and press to enter the Custom FX. You can choose to enter Picker FX, Music FX, or Touchbar FX interface. Each type can save 10 custom FXs. In the name of each FX, "NO FX" means unsaved FX, and "Untitled" means saved FX.



3.10 Exit

Press the MENU button to enter the menu mode, rotate and short press the INT wheel to select exit, you can return to the initial interface of CCT mode.

3.11 Preset function

There are 4 preset buttons located on the bottom row of the control box. Once you have set your light to the desired output, long press and hold one of the four buttons (1, 2, 3, or 4) to start the Save Preset procedure. Use the INT control wheel to select "YES" or "NO".

You can then use those preset buttons in any Lighting Mode and it will activate the mode and settings you previously saved to that preset. You can save a nearly infinite number of presets using the Sidus Link mobile app.

4. Use of Sidus Link APP

You can search for sidus link in App store and Android market to download professional control software to control Aitus lamps. For more detailed usage, please visit: sidus.link/app/help

Specifications

CCT	2500 K - 7500 K
CRI	≥ 95
TLCI	≥ 96
CQS	≥ 96
SSI (D56)	≥ 74
SSI (D32)	≥ 83
Beam angle	45°
Power Output	≤ 60 W
Power Input	≤ 78 W
Operating Current	4.5 A
Operating Voltage	100 V - 240 V 50 Hz / 60 Hz
NP-F Battery Operating Voltage	6.5 V - 8.4 V
V/Anton Bauer Mount Battery Operating Voltage	12.5 V - 16.8 V
Operating temperature	-20 °C - +45 °C / -4 °F - +113 °F
Control Methods	Manual, Sidus Link APP
Wireless Operating Range (Bluetooth)	≥ 80 m / 262.5 ft
Screen Type	OLED
Cooling Method	Active Cooling
Head Cable	2-Pin DC Head Cable (3 m)
Power cable	Locking Power cable (1.5 m)
Lamp Head Size	27.10 * 21.30 * 4.34 cm
Lamp Head Weight	1880 g

Photometrics

CCT	Distance	0.5 m	1 m	2 m
2500 K	Lux	17400	5000	1300
	Fc	1616	465	121
3200 K	Lux	18500	5200	1400
	Fc	1719	483	130
4300 K	Lux	19500	5600	1460
	Fc	1812	520	136
5600 K	Lux	20000	5900	1550
	Fc	1858	548	144
7500 K	Lux	22000	6300	1650
	Fc	2044	585	153

* This is an averaged result. The luminance of your individual unit may vary slightly from this data.

Trademark statement

Sony is a trademark and product model of Sony Corporation in China or other countries.

Aputure®

GUARANTEE CARD

Serial No.	
Item Name	
Purchase Date	
Buyer Name	
Buyer Phone	
Buyer Add	
Franchiser Seal	

Aputure®

Aputure Imaging Industries Co., Ltd.

Inspection: Qualified

Add: F/3, Building 21, Longjun Industrial Estate, HePing West Road, Shenzhen, Guangdong

Service Warranty (EN)

Aputure Imaging Industries Co., Ltd. warrants the original consumer purchaser from defects in material and workmanship for a period of one (1) Year after the date of purchase. For more details of warranty visit www.aputure.com

Important:

Keep your original sales receipt. Be sure the dealer has written on it the date, serial No. of the product. This information is required for warranty service.

This warranty does not cover:

- Damage that is the result of misuse, abuse, accident (including but not limited to damage by water), faulty connection, defective or maladjusted associated equipment, or the use of the product with equipment for which it was not intended.
- Cosmetic defects that appear more than thirty (30) days after the date of purchase. Cosmetic damage caused by improper handling is also excluded.
- Damage that occurs while the product is being shipped to whoever will service it.

This warranty is void if:

- The product identification or serial No. label is removed or defaced in any way.
- The product is serviced or repaired by any one other than Aputure or an authorized Aputure dealer or service agency.

Aputure Imaging Industries Co., Ltd.

Add: F/3, Building 21, Longjun Industrial estate,
HePing West Road, Shenzhen, Guangdong

E-MAIL: cs@aputure.com

Sales Contact: (86)0755-83285569-613