

amaran[®]

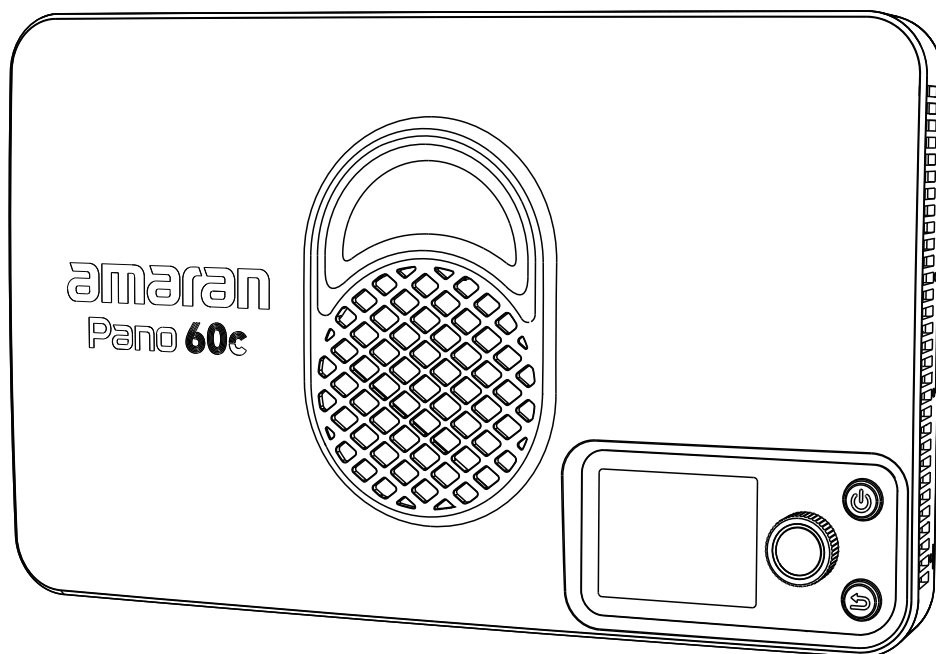

amaran Pano 60c

Product Manual

English

Table of Content

Introduction.....	03
Components List.....	04
Product Overview	06
Operations.....	08
1. Power Supply.....	08
2. Power On/Off.....	10
3. Light Installation	10
4. Softbox Installation.....	13
5. Light Control Grid Installation	13
6. Diffuser Installation.....	14
7. Barn Doors Installation.....	15
8.Main Menu.....	15
8.1 CCT	15
8.2 HSI	16
8.3 RGB.....	17
8.4 FX.....	17
8.5 Bluetooth Reset	18
8.6 Custom Mode.....	18
8.7 Language.....	19
8.8 Fan Mode	19
8.9 Studio Mode	20
8.10 Expanded CCT.....	20
9. Firmware Upgrade	20
Using the amaran App.....	21
Specifications	22
Photometrics.....	23
Important Safety Instructions	24
FCC Compliance Statement	25
Disclaimer.....	26

Introduction

Thank you for purchasing the amaran Pano 60c.

Designed for on-the-go creators, the amaran Pano 60c is a compact, 60W full-color panel light combining unmatched brightness with exceptional portability. Its slim and lightweight design makes it perfect for outdoor mobile shoots or travelling to on-location studio setups, while its streamlined USB-C PD power delivery and amaran Ace E-Lock compatibility offers greater power flexibility for any shooting environment. And paired with included lighting accessories, the amaran Pano 60c is the ideal all-in-one, versatile mobile shooting kit that can adapt to any creative project.

Components List

Please make sure all accessories listed below are complete before using. If not, please contact your sellers immediately.

amaran Pano 60c (Base Version)



amaran Pano 60c ×1

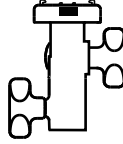

amaran Ace Lock to Light Stand Adapter ×1



amaran Pano 60c Diffuser ×1

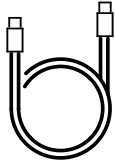

amaran USB-C Locking Charging Cable (3m) ×1

amaran Pano 60c Kit

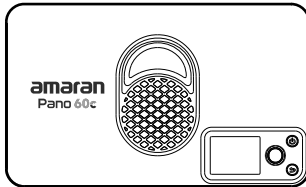

amaran Pano 60c ×1

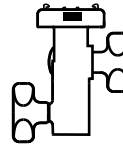

amaran Ace Lock to Light Stand Adapter ×1



amaran Pano 60c Diffuser ×1

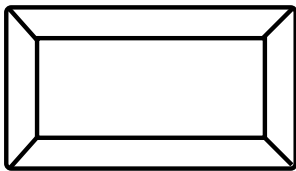

amaran Pano 60c Softbox ×1

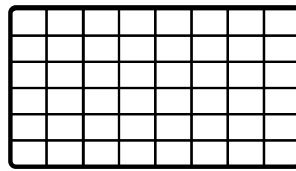

amaran Pano 60c Light Control Grid ×1

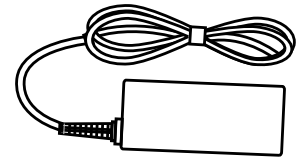

amaran 65W USB-C PD Locking Power Adapter ×1

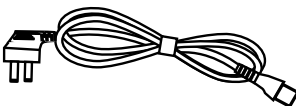

amaran AC Cable ×1

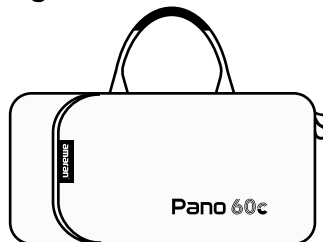

amaran Pano 60c Kit Carrying Case ×1

amaran Pano 60c 2-Light Kit



amaran Pano 60c ×2

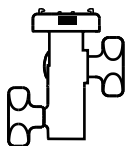

amaran Ace Lock
to Light Stand Adapter ×2

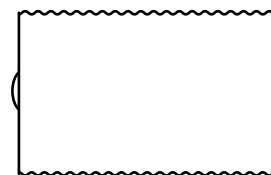

amaran Pano 60c
Diffuser ×2

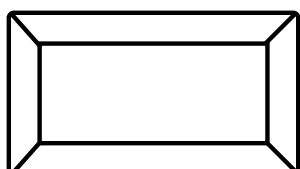

amaran Pano 60c
Softbox ×2

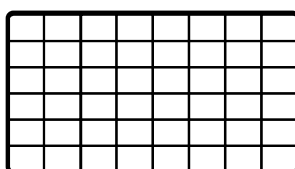

amaran Pano 60c
Light Control Grid ×2

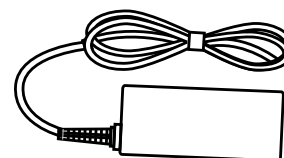

amaran 65W USB-C PD
Locking Power Adapter ×2

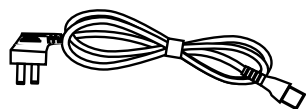

amaran AC Cable ×2

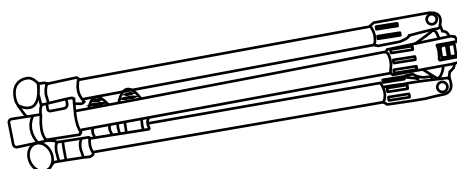

amaran Light Stand (2m) ×2

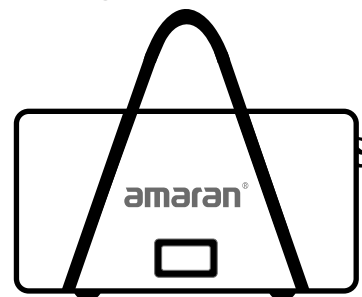

amaran Pano 60c 2-Light
Kit Carrying Case x1

Tip: The illustrations in the manual are diagrams for reference only. Due to the continuous development of new versions of the product, if there are any differences between the product and the user manual diagrams, please refer to the product itself.

Product Overview

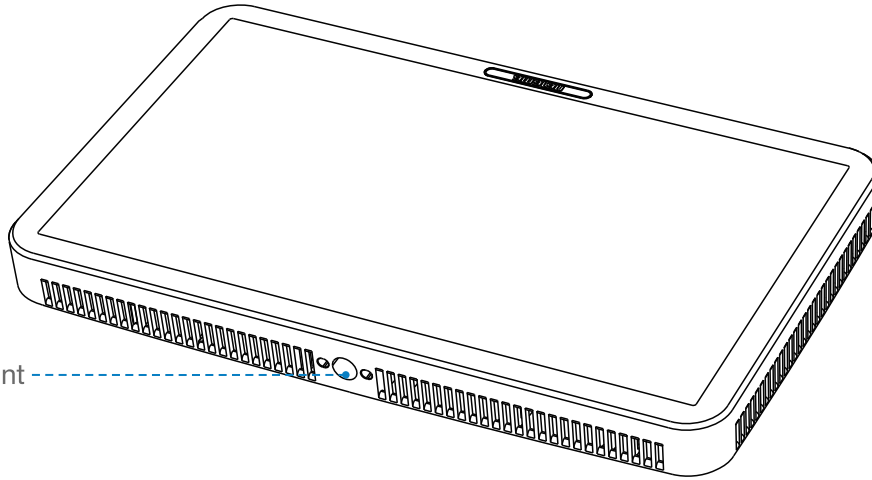

1/4-20in Screw Mount

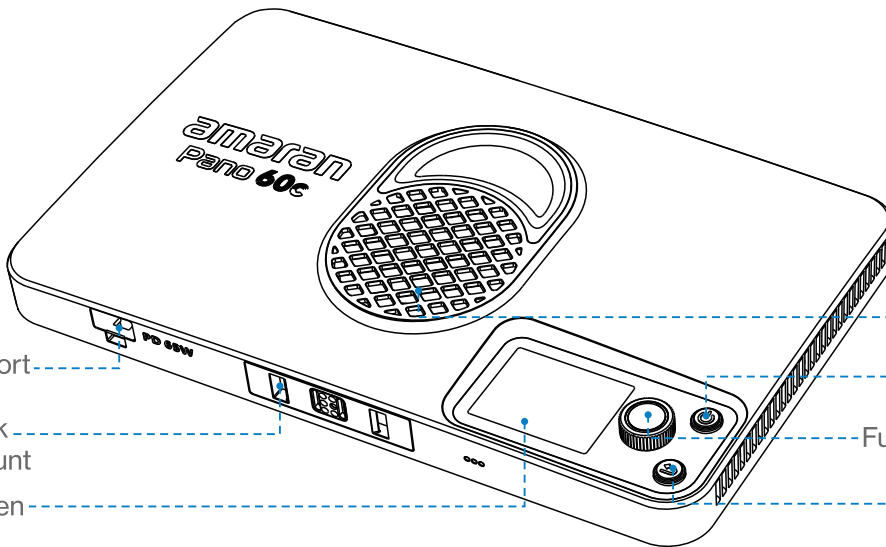

USB-C Charging Port

amaran Ace E-Lock
Quick-Release Mount

Display Menu Screen

Fan Vent

Power Button

Function Control Knob

Return Button

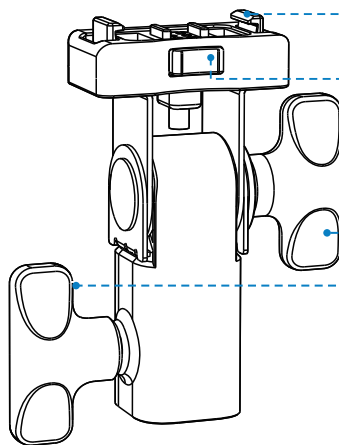

amaran Ace Lock Contact Pins

amaran Ace Lock Unlock Button

Tilting Bracket Knob

Locking Knob

Power Button	Press to turn the light on, and hold for 1 second to turn the light off. The indicator light will be on when the light is powered on.
Return Button	Click to return to the previous menu screen. Hold or double click on the return button to execute customizable shortcuts set in Custom Mode.
Function Control Knob	Rotate to toggle the menu or adjust values and lighting settings. Press the knob to confirm parameters.
Display Menu Screen	Displays settings and status of your light.
Fan Vent	Helps the light dissipate heat. Please do not block the fan vent when using the light.
amaran Ace E-Lock Quick-Release Mount	Install and disassemble the light in less than a second with the amaran Ace Lock ecosystem. The light can also be powered by the amaran Peak power bank Accessory. <i>* The amaran Peak power bank accessory is sold separately.</i>
USB-C Charging Port	Used to charge the fixture via a PD-supported power supply. The included amaran 65W USB-C PD Locking Power Adapter is pull-resistant, avoid pulling the cable with force to prevent damage.
1/4-20in Screw Mount	Mount the light onto 1/4-20in tripods or other equipment.
amaran Ace Lock Contact Pins	Locks into place on the light's amaran Ace Lock quick-release mount to secure the light.
amaran Ace Lock Unlock Button	Press the button to detach the amaran Ace Lock mounting bracket from the light.
Tilting Bracket Knob	Rotate to lock and unlock the mounting bracket to adjust the angle of the light.
Locking Knob	Rotate to lock and unlock the mounting bracket from the light stand.

Operations

Power Supply

Power Supply Method 1:

Use the included amaran 65W USB-C PD Locking Power Adapter to supply power to the light. Plug the end of the Power Adapter into the USB-C Charging Port of the light. The included Locking Power Adapter is pull-resistant. Press the lock when inserting and removing the cable, and avoid pulling the cable with force to prevent damage.

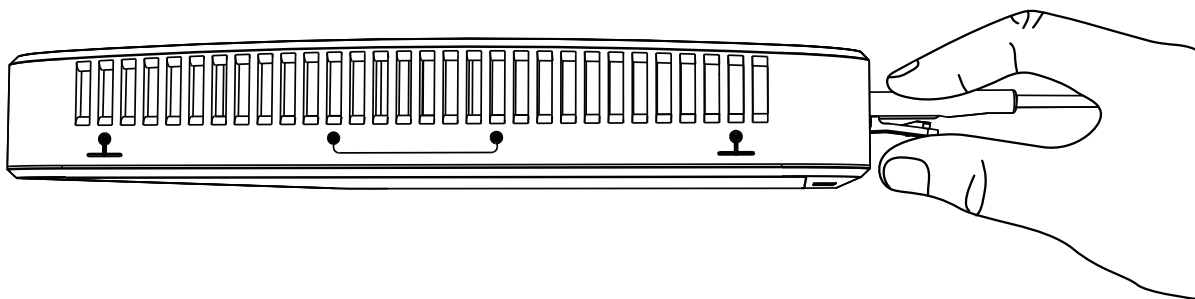
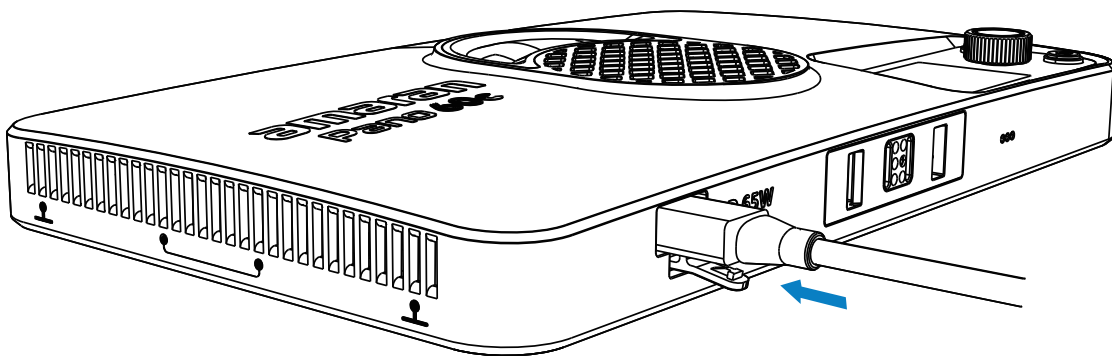

Power Supply Method 2:

Supply power to the light via other PD power supply devices or power banks. Plug the output port of the PD power supply device into the USB-C Charging Port of the light. Please ensure that the power bank can output a minimum of 36W of power. If a power bank below 65W of power output is used, the brightness of the lamp will be reduced or may be unable to light up.

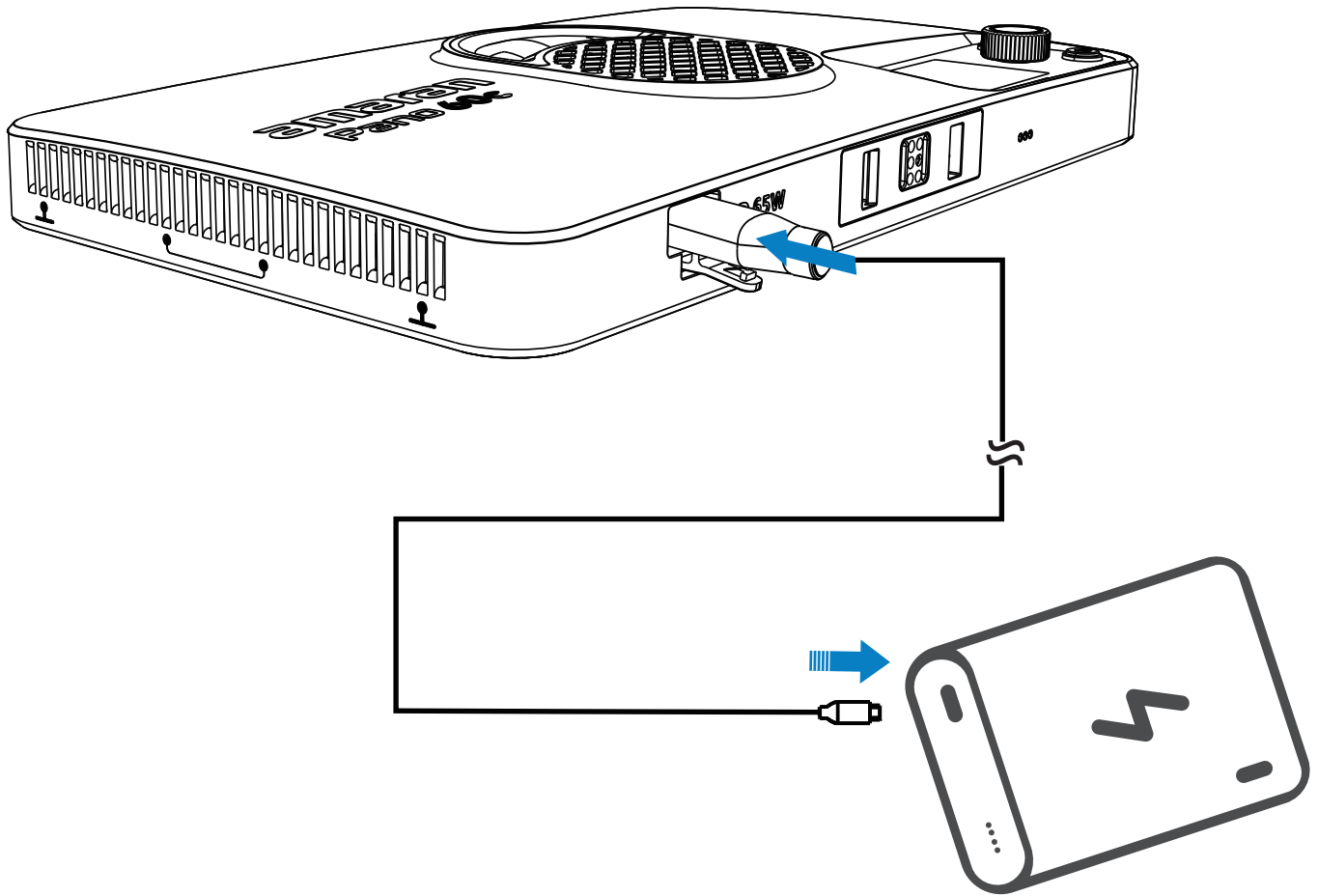

Power Supply Method 3:

Supply power to the light via the amaran Peak portable power supply. The battery handle features amaran Ace E-Lock Contact Pins, and will power the light on when mounted via the amaran Ace E-Lock Quick-Release Mount. * Supply power to the light via the amaran Peak portable power supply.

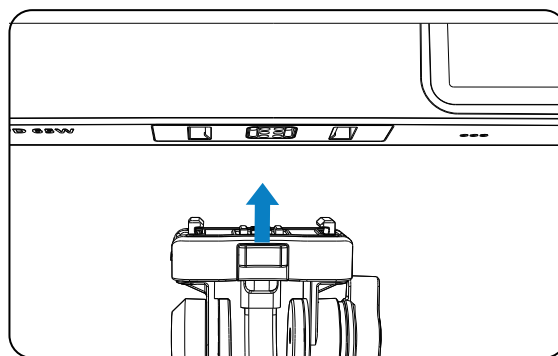

* The amaran Peak power bank accessory is sold separately.

* The amaran Pano 60c supports power supply standards of USB PD3.0 and above, but is not compatible with some third-party private charging protocols. Please ensure to select the appropriate power supply device. If the selected power supply device cannot power the light at full power, a pop-up window will appear on the display menu screen and limit the maximum brightness.

2. Power On/Off

1. After connecting to the power supply, press the power button on the back of the fixture to turn the light on, and hold for 1 second to turn the light off. The light will resume to its previous settings prior to turning off.
2. You can select your preferred language when you turn the light on for the first time. Rotate the knob to select your language. Click to confirm.

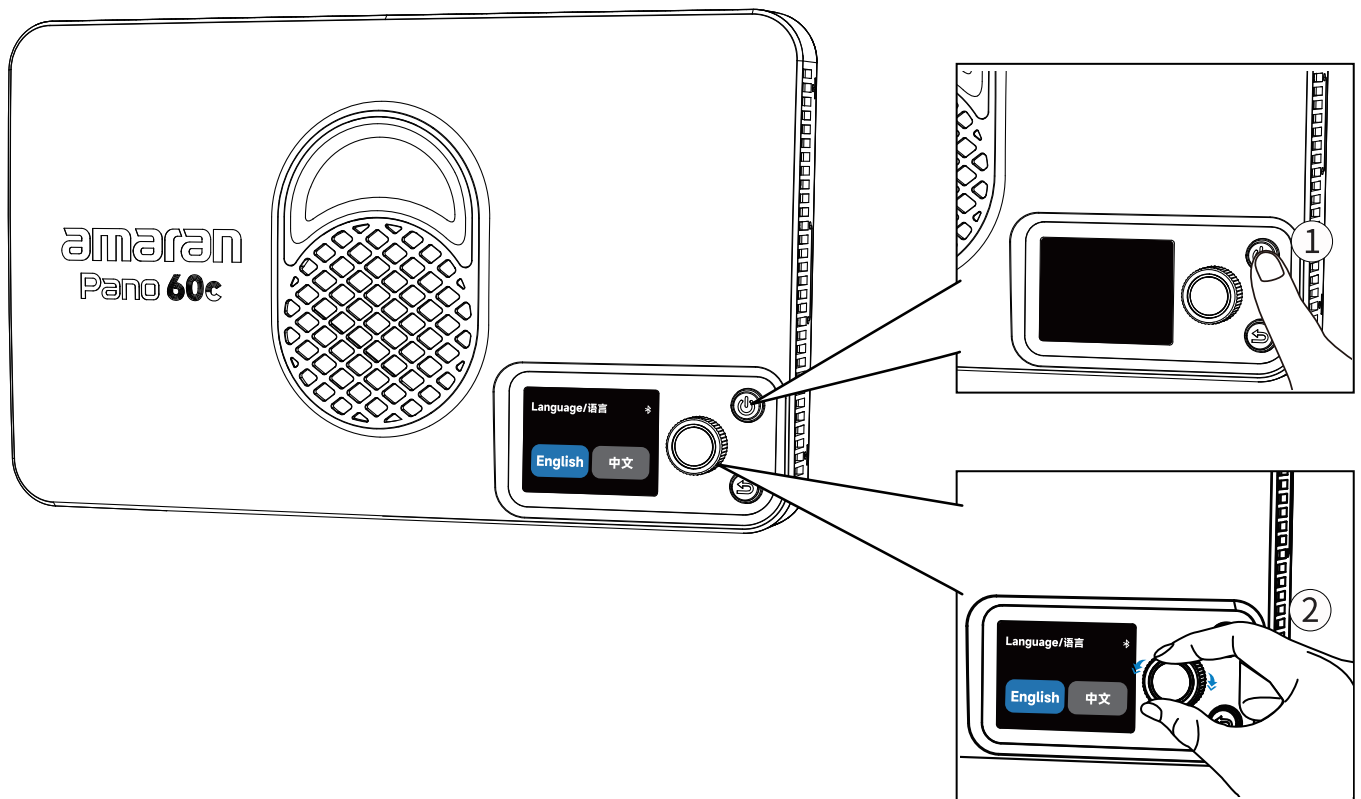

3. Light Installation

1. Installing the amaran Ace Lock Adapter:

Align the contact pins on the mounting bracket to the light's amaran Ace Lock quick release mount. Press the blue release key and push towards the bottom of the light. The mounting bracket is securely attached to the light when the pins are embedded into the amaran Ace lock mount and when you hear a clicking noise.

Please ensure that the blue release key is facing the back of the light to avoid reverse installation.

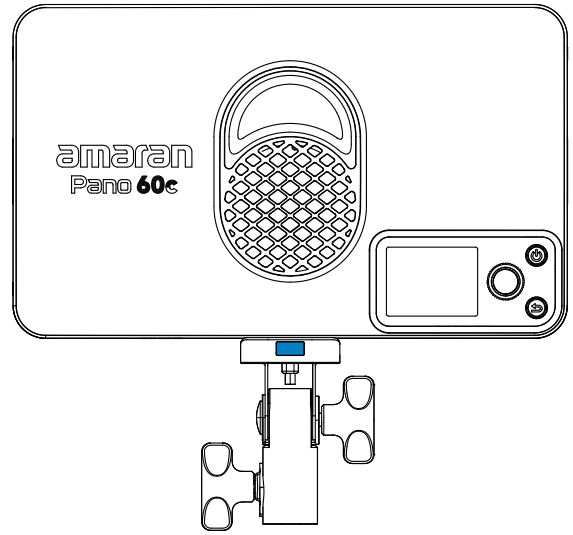
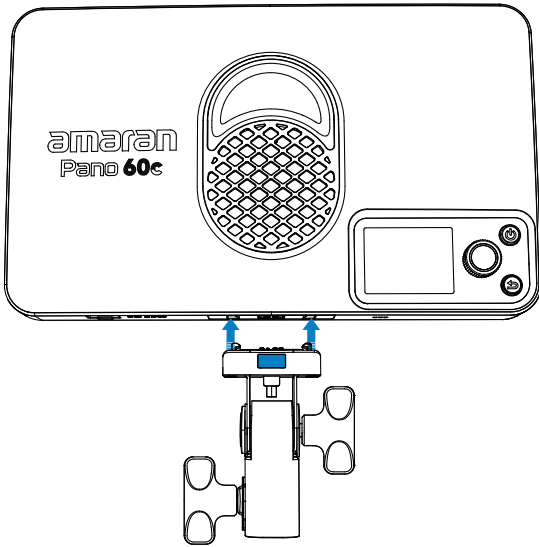

2. Installing Onto A Light Stand:

With the mounting bracket installed onto the light, place the end of the mounting bracket onto the light stand and turn the locking knob to secure into place. Adjust the angle of the light and turn the tilting bracket knob to secure into place.

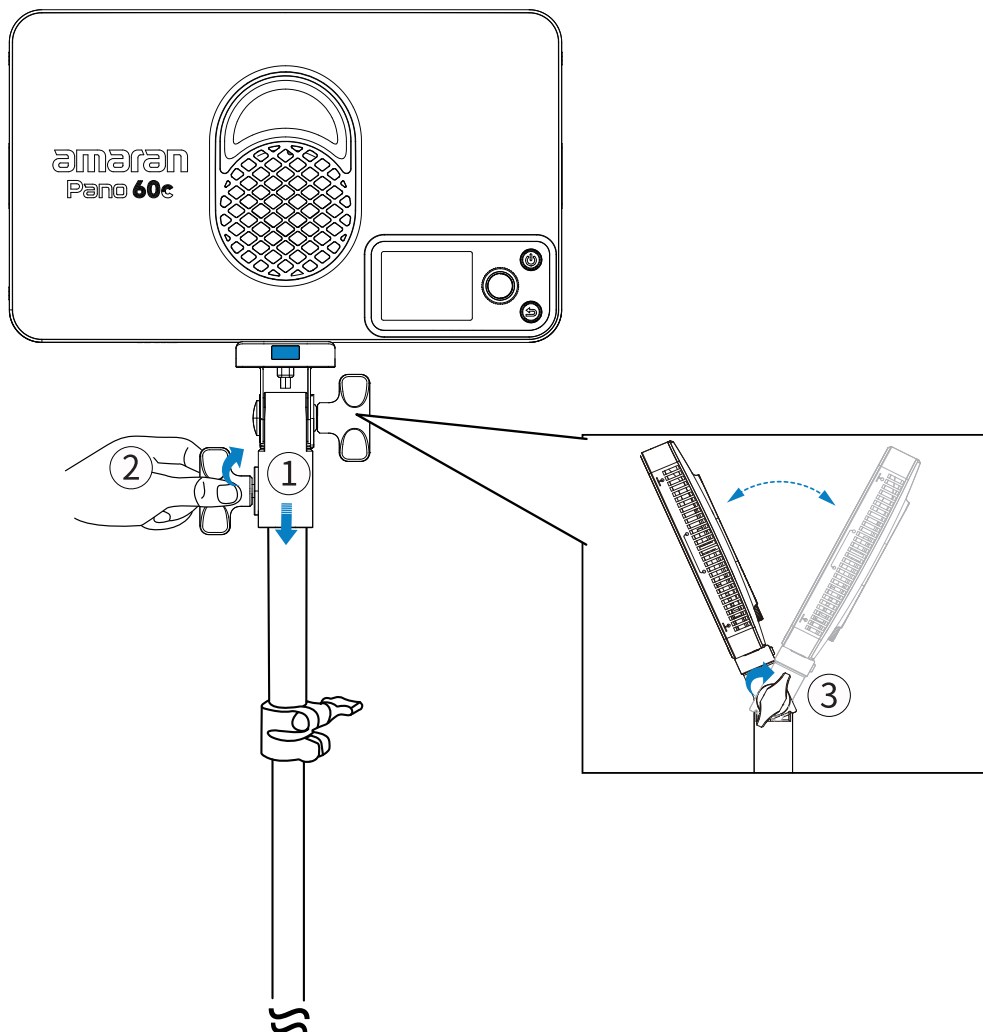

3. Disassembling the Light:

To disassemble, press the blue release key on the mounting bracket and pull the light upwards away from the mounting bracket. To avoid damaging the light and bracket, do not disassemble by force.

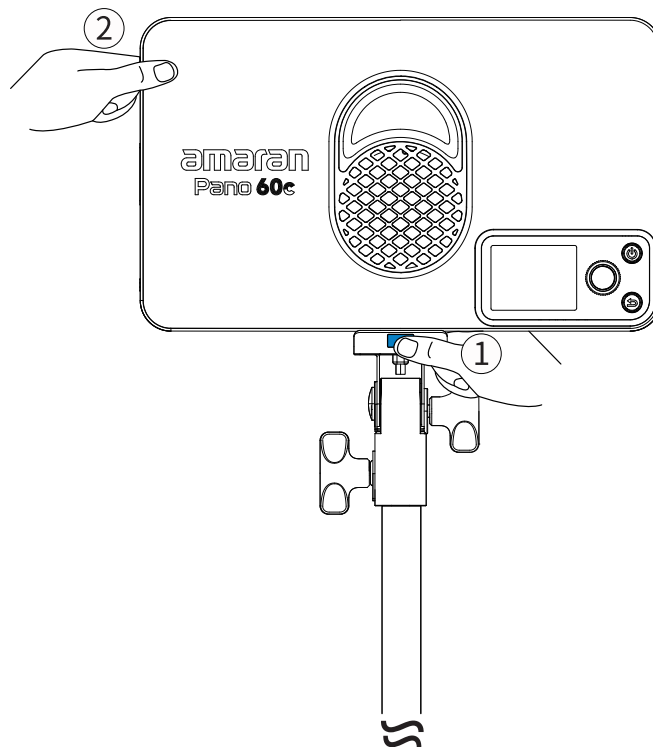

4. Installing via 1/4-20in Screw Mount:

The top of the light features a 1/4-20in screw mount for mounting the light onto 1/4-20in tripods or other equipment.

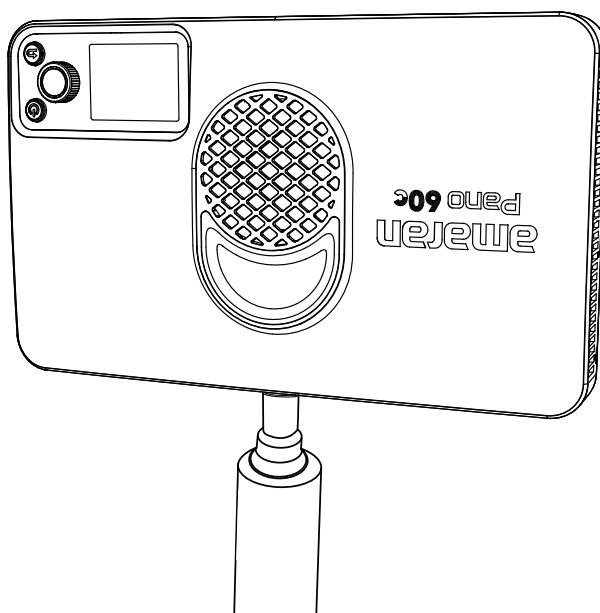

4. Softbox Installation

1. Unfold the softbox and place the diffusion cloth side downwards onto a flat surface.
2. To install the softbox onto the light, place the light with the light-emitting surface side downwards onto the frame of the softbox. Pull the handles on the sides of the softbox to ensure that the softbox is fully unfolded and that the light is firmly installed into the softbox frame.
3. Pull the elastic straps on the softbox over the light. Adjust the position of the softbox and ensure that the edges of the softbox are aligned with the edges of the light.

①

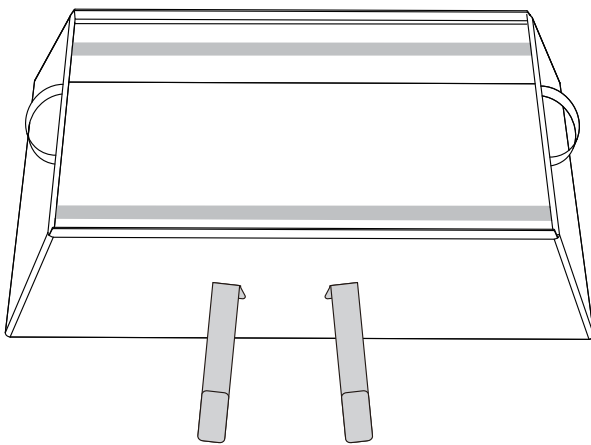

②

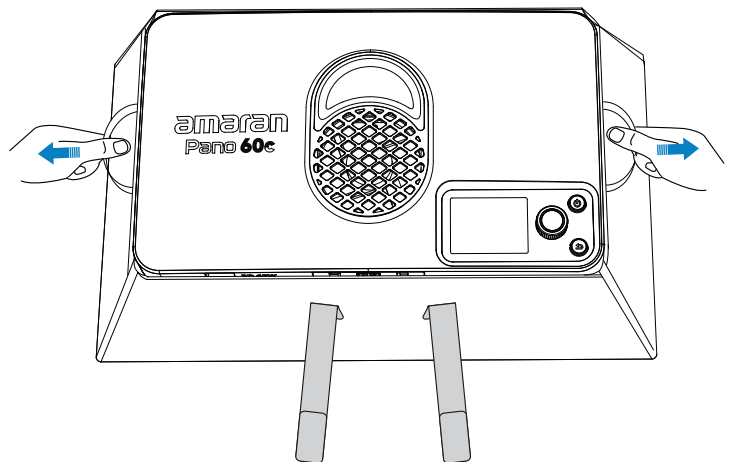

③

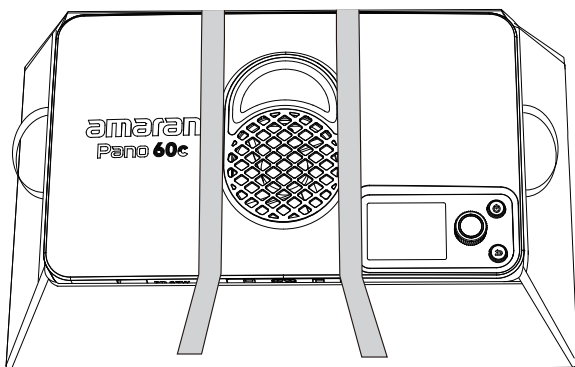

Note: To prevent the softbox from blocking the fan and affecting heat dissipation or light spill, please ensure that the softbox securely wraps around the edges of the light.

5. Light Control Grid Installation

1. Please ensure that the softbox is fully opened prior to installing the light control grid.
2. To install the light control grid onto the softbox, expand the light control grid and align with the 4 corners of the softbox.
3. To ensure that the grid is firmly installed onto the softbox, fasten the Velcro around the light control grid to the softbox and ensure it is flat.

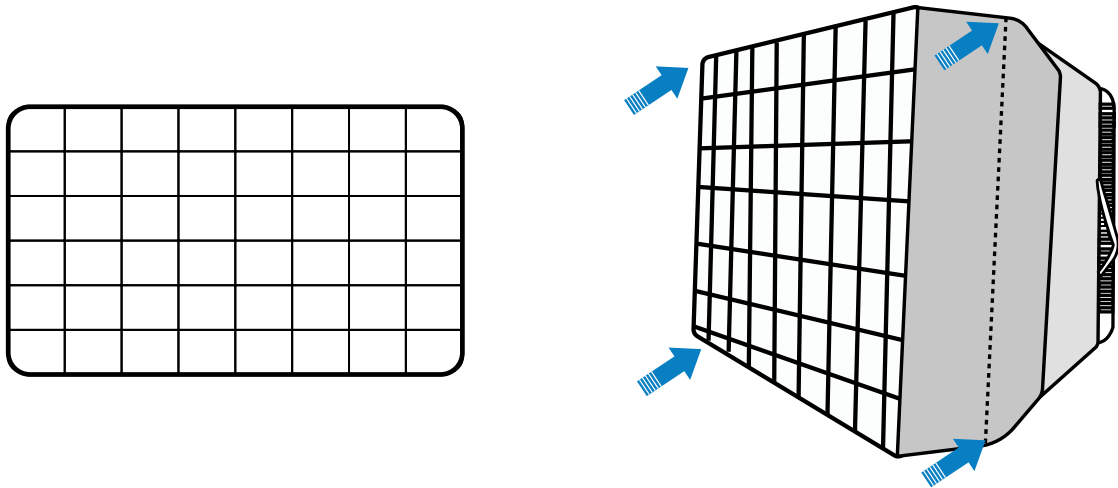

6. Diffuser Installation

1. Unfold the diffuser and pull the hook side towards the light.
2. To install the diffuser onto the softbox, place the hook on the side of the diffuser into the light's heat dissipation hole. Repeat to hook on the other side to securely install the diffuser cover.

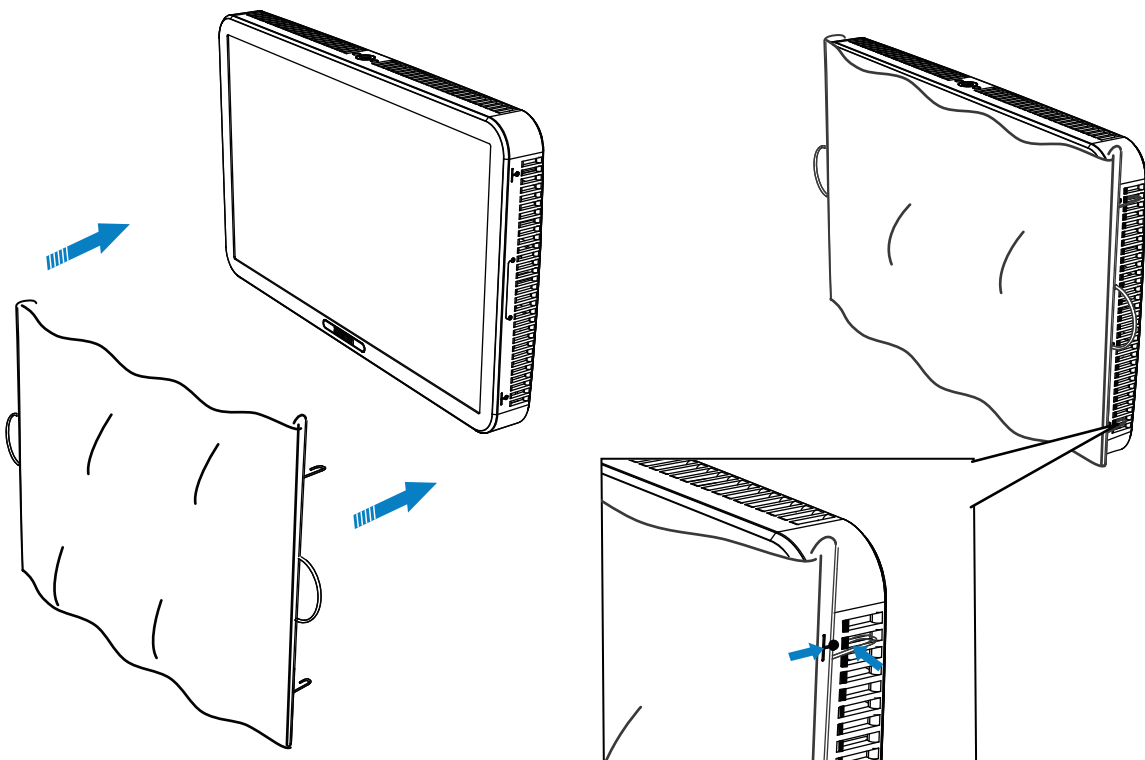

Note: Please ensure that the diffuser is positioned correctly to prevent it from exceeding the edges of the light.

7. Barn Doors Installation*

1. Ensure that the barn door leaves are closed and place facing downwards on a flat surface. Place the light into the frame of the barn doors.
2. To install the barn doors onto the light, place the wire clasp into the light's heat dissipation hole. Repeat to place on the other side to securely install the barn doors.

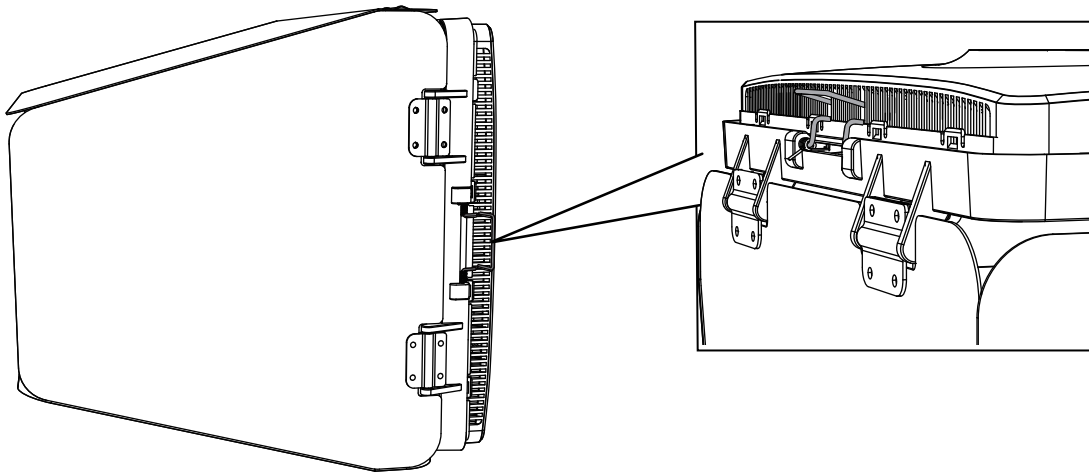

**The amaran Pano 60c Barn Doors are sold separately.*

8. Main Menu

Rotate and press the knob to select light modes and settings.

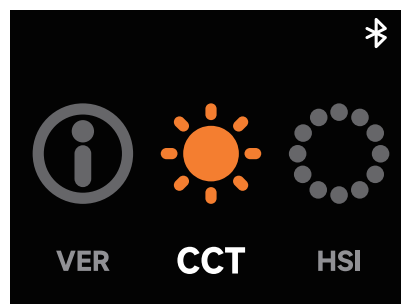

8.1 CCT

Rotate and press the knob to enter CCT mode from the main menu. In CCT mode, press the knob to select INT or CCT and rotate the dial to adjust the corresponding value.

1. INT (Intensity): Adjust your light's brightness from 0%-100%.

2. CCT (Correlated Color Temperature): Adjust your light's color temperature from warm white (2,300K CCT) to cool white (10,000K CCT).

3. G/M (Green-Magenta): Adjust the green-magenta shift in ± 10 increments.

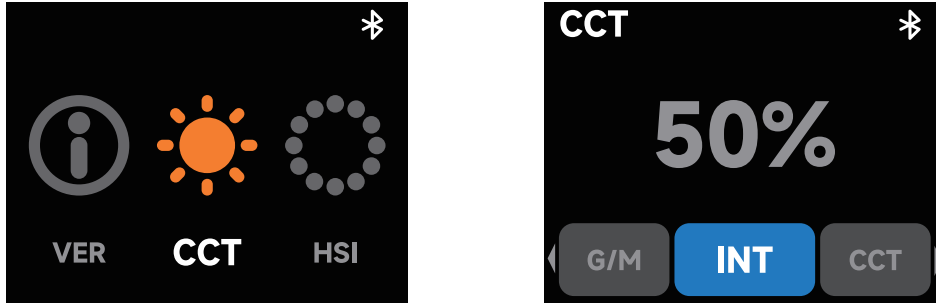

4. After 3 minutes of inactivity while the light is in CCT Mode, it will automatically switch to "Quick Operation Mode". Quick Operation Mode allows you to quickly adjust your light's settings without toggling through the menu.

The menu screen will display the current color temperature value and brightness level. Rotate the control knob to adjust your brightness levels. Press and rotate the knob to adjust your color temperature value from warm white to cool white.

Press the Return button to exit Quick Operation Mode and return to your previous interface.

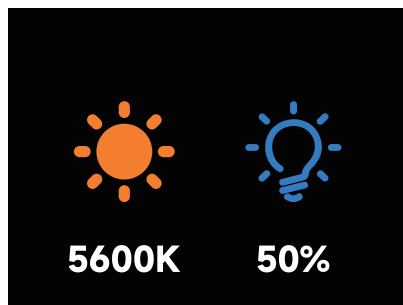

8.2 HSI

Rotate and press the knob to enter HSI mode from the main menu. In HSI, press the knob to select INT, HUE, or SAT and rotate the dial to adjust the corresponding value.

1. INT (Intensity): Adjust your light's brightness from 0%-100%.

2. HUE: Adjust your light's hue value from 1° to 360° .

3. SAT (Saturation): Adjust the saturation of the color from 0%-100%.

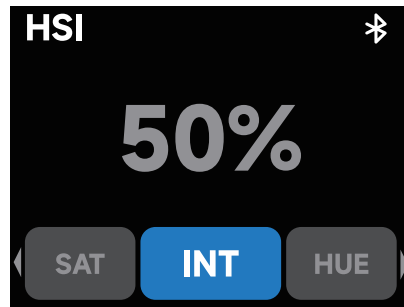
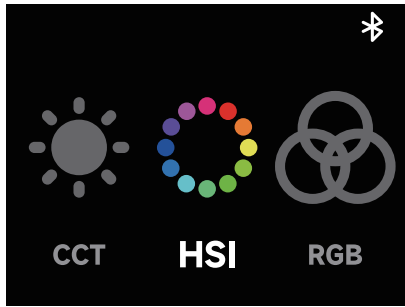

8.3 RGB

Rotate and press the knob to enter RGB mode from the main menu. In RGB, press the knob to select INT, Red, Green, or Blue and rotate the dial to adjust the corresponding value.

1. **INT (Intensity):** Adjust your light's brightness from 0%-100%.
2. **Red:** Adjust your light's Red value from 0%-100%.
3. **Green:** Adjust your light's Green value from 0%-100%.
4. **Blue:** Adjust your light's Blue value from 0%-100%.

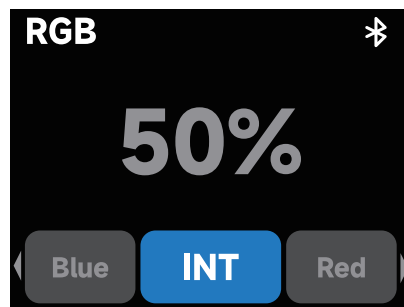

8.4 FX

Rotate and press the knob to enter FX mode from the main menu. In FX, rotate and press the knob to select your lighting effect. Press again to enter the settings and rotate the dial to adjust the corresponding value.

Supported lighting effects:

Fireworks	Faulty Bulb	Lightning	TV	Pulsing	Strobe
Explosion	Fire	Paparazzi	Welding	Cop Car	Party Lights

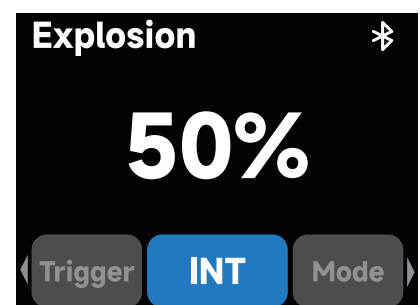
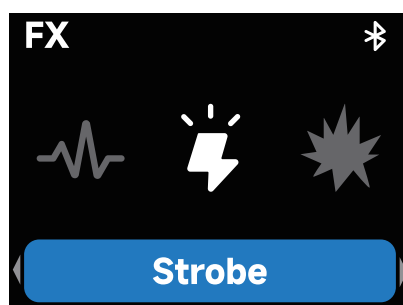
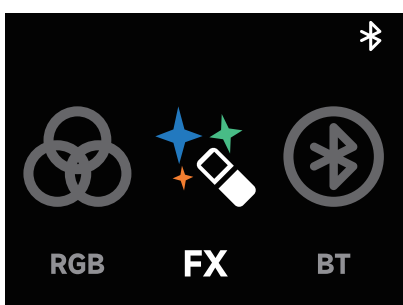

8.5 Bluetooth Reset

Rotate and press the knob to enter BT mode from the main menu. Hold down on the knob until the end of the progress bar. Release the knob to cancel.

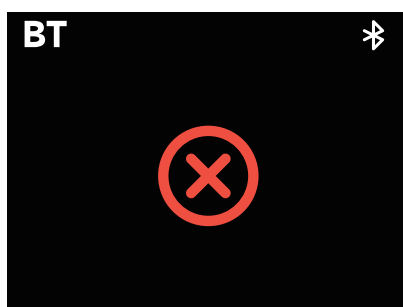
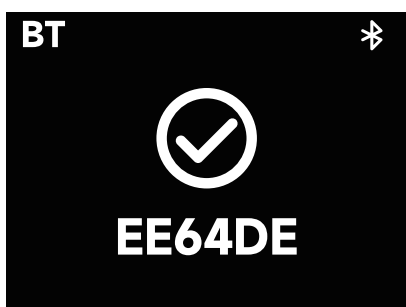
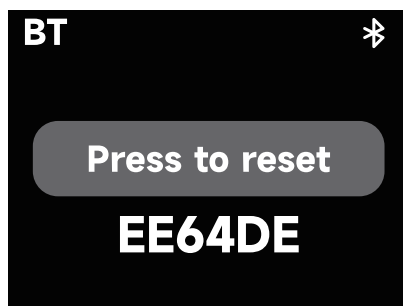
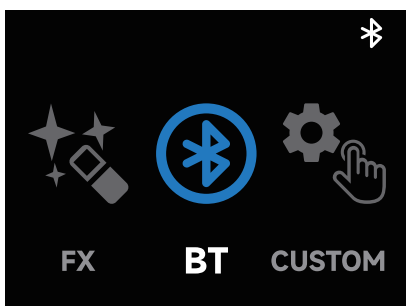

Bluetooth reset is successful.

Bluetooth reset is unsuccessful.
Please reset Bluetooth again.

8.6 Custom Mode

Rotate and press the knob to enter Custom mode from the main menu. In Custom mode, press the knob to select customizable shortcuts for long press (Hold) or double click (Double) of the Return button. Rotate the dial to select between None/CCT/Rotation/HSI/BT Reset shortcut functions. Short press of the return button defaults to the return/back function and cannot be changed.

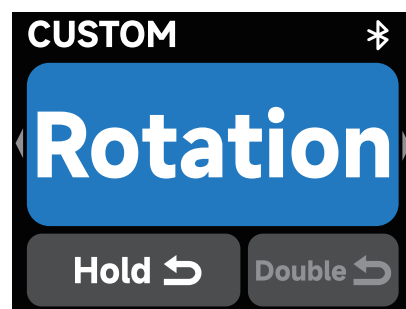
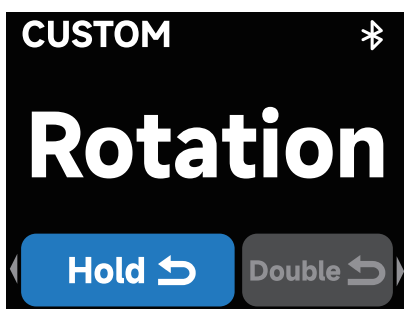
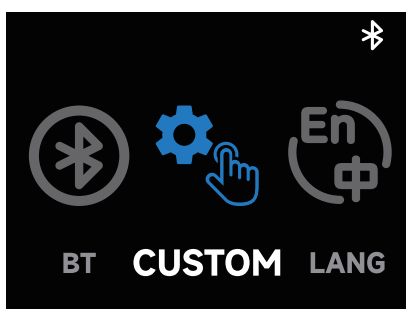

8.7 Language

Rotate and press the knob to enter Language settings from the main menu. In Language, rotate the dial to toggle between English or Chinese. Press the knob to confirm your language.

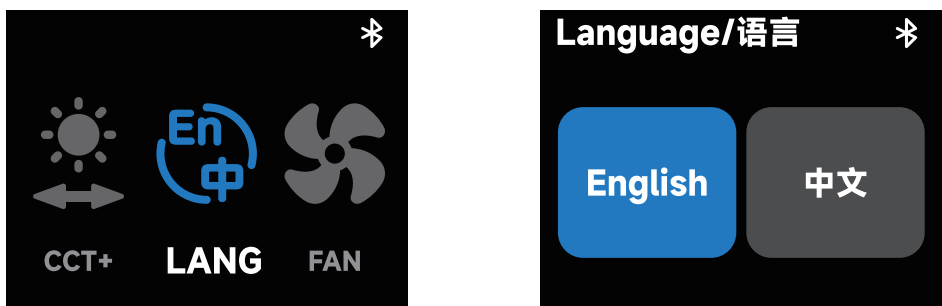

8.8 Fan Mode

Rotate and press the knob to enter Fan mode from the main menu. In Fan mode, rotate the dial to toggle between Silent and Smart fan mode. Press the knob to confirm your settings.

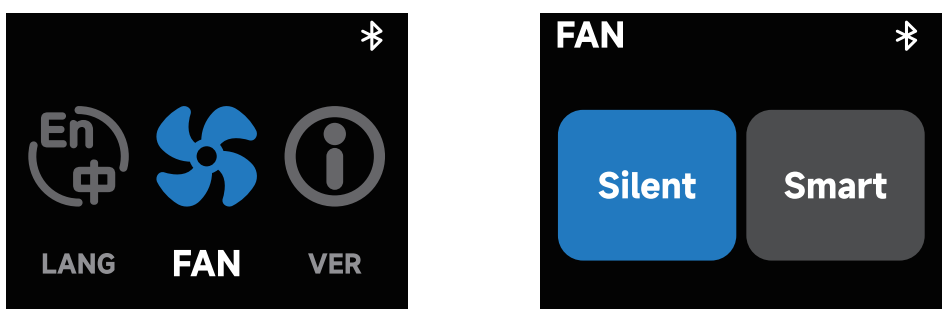

Silent Mode: The fan will be completely turned off, and the light will not produce any noise.

The power output will be limited to 17W.

Smart Mode: The fan speed will automatically adjust according to the temperature of the light.

8.9 Studio Mode

Rotate and press the knob to enter Studio mode from the main menu. Press the knob to cycle between On/Off. When Studio mode is turned on, the light will automatically turn on after connecting to a power supply, reducing the need to manually press the power button.

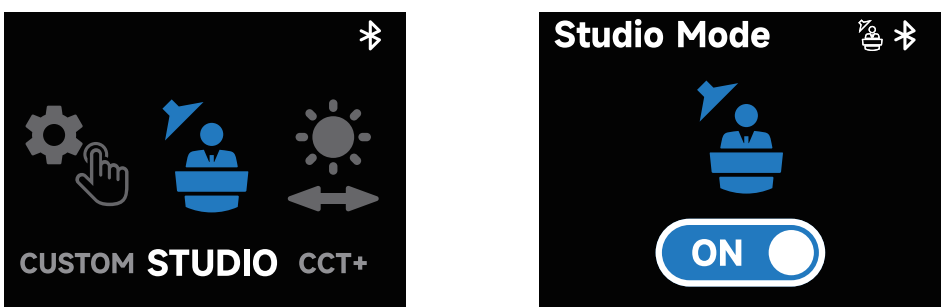

8.10 Expanded CCT

Rotate and press the knob to enter the Expanded CCT mode from the main menu. Press the knob to cycle between On/Off. When Expanded CCT mode is turned on, the adjustable color temperature in CCT mode is expanded to 1,800K to 20,000K CCT. Please note that the color rendering when in the expanded CCT range is lower.

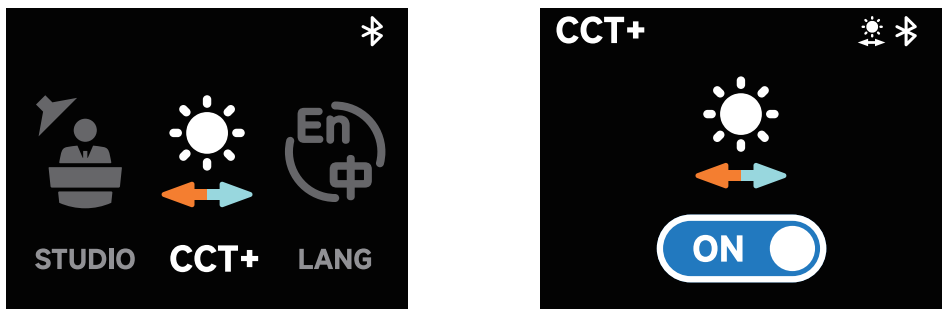

9. Firmware Upgrade

Firmware updates can be updated online via the amaran app or Sidus Link.

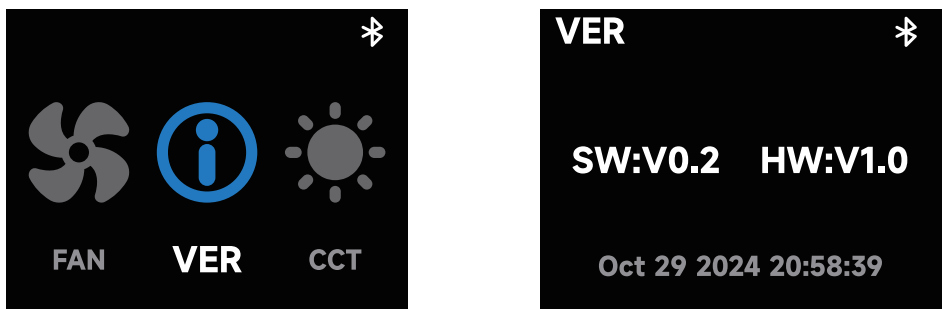

Using the amaran App

You can download the amaran mobile app from the iOS App Store, Google Play Store, and other platforms for enhancing the functionality of the light. You can download the amaran desktop app for Mac and Windows from the amaran website. Please visit amarancreators.com for more details on how to use the app to control your amaran lights.



amaran App



amarancreators.com

Specifications

Max Power Input	65W	Max Power Output	60W
CCT	2,300-10,000K	Lumens	6,790lumens@5600K; 6,190lumens@3200K
CRI	96	TLCI	97
TM-30 Rg (Average)	101	TM-30 Rf (Average)	93
SSI(D32)	84	SSI (D56)	74
Beam Angle (No Accessory)	45°	Color Chipset	RGBWW
Operating Temperature	-10°C - 40°C / 14°F - 104°F	Storage Temperature	-20°C - 80°C / -4°F - 176°F
Control Methods	On-board, amaran App, Sidus Link	Firmware Upgradeable	App
Screen Type	TFT	Wireless Operating Range (Bluetooth)	≤80m / ≤262.5ft
Adapter Input Voltage	AC 110V-220V	Cooling Method	Fan cooling
Operating Voltage	PD3.0 20V	Adapter Cable Length	2.5m/8.20ft
Beam Angle (Light Control Grid)	45°	AC Cable Length	2m/6.56ft
Light Dimensions	25.5*15.5*3cm/10*6.1*1.2in	Light Weight	0.61kg/1.3lb
Softbox Dimensions	31.5*20.5*10.5cm/12.4*8*4.1in	Softbox Weight	0.26kg/0.6lb
Light Control Grid Dimensions	32*20*17cm/12.6*7.9*6.7in	Light Control Grid Weight	0.08kg/0.2lb

**The above technical specifications are from the Aputure laboratory, and there may be some variation between individual units.*

Photometrics

CCT	Distance	No Accessories	Softbox	Light Control Grid	Diffuser
2,300K	0.5m	19,240 lux	6,210 lux	5,030 lux	4,660 lux
		1,787 fc	577 fc	467 fc	433 fc
	1m	5,460 lux	1,435 lux	1,306 lux	1,237 lux
		507 fc	133 fc	121 fc	115 fc
3,200K	0.5m	20,470 lux	6,650 lux	5,370 lux	4,980 lux
		1,902 fc	618 fc	499 fc	463 fc
	1m	5,800 lux	1,528 lux	1,396 lux	1,323 lux
		539 fc	142 fc	130 fc	123 fc
4,300K	0.5m	21,030 lux	6,860 lux	5,550 lux	5,150 lux
		1,954 fc	637 fc	516 fc	478 fc
	1m	5,990 lux	1,580 lux	1,443 lux	1,363 lux
		556 fc	147 fc	134 fc	127 fc
5,600K	0.5m	21,790 lux	7,130 lux	5,780 lux	5,350 lux
		2,024 fc	662 fc	537 fc	497 fc
	1m	6,290 lux	1,642 lux	1,501 lux	1,416 lux
		584 fc	153 fc	139 fc	132 fc
6,500K	0.5m	22,220 lux	7,310 lux	5,910 lux	5,480 lux
		2,064 fc	679 fc	549 fc	509 fc
	1m	6,260 lux	1,680 lux	1,538 lux	1,449 lux
		582 fc	156 fc	143 fc	135 fc
10,000K	0.5m	20,630 lux	6,830 lux	5,490 lux	5,100 lux
		1,917 fc	635 fc	510 fc	474 fc
	1m	5,800 lux	1,564 lux	1,438 lux	1,357 lux
		539 fc	145 fc	134 fc	126 fc
R	0.5m	5,730 lux	1,930 lux	1,500 lux	1,403 lux
		532 fc	179 fc	139 fc	130 fc
	1m	1,756 lux	434 lux	425 lux	367 lux
		163 fc	40 fc	39 fc	34 fc
G	0.5m	9,648 lux	3,240 lux	2,614 lux	2,435 lux
		896 fc	300 fc	243 fc	226 fc
	1m	2,826 lux	754 lux	689 lux	637 lux
		263 fc	70 fc	64 fc	59 fc
B	0.5m	2,084 lux	706 lux	570 lux	565 lux
		194 fc	66 fc	53 fc	52 fc
	1m	602 lux	164 lux	148 lux	147 lux
		56 fc	15 fc	14 fc	14 fc

Important Safety Instructions

When using the amaran Pano 60c, basic safety precautions should always be followed, including the following:

1. Read and understand all instructions before using.
2. Please have the product checked by an authorized service personnel agent if the product has a problem. Any malfunctions caused by unauthorized disassembly are not covered by the warranty. The user may pay for maintenance.
3. Please do not place the fixture in high temperature environments for long periods of time, as it will accelerate the aging of the product and shorten its service life.
4. Close supervision is necessary when any fixture is used by or near children. Do not leave the fixture unattended while in use.
5. Do not operate the fixture if a cord is damaged, or if the fixture has been dropped or damaged, until it has been examined by qualified service personnel.
6. This fixture is not waterproof. Please do not use the light fixture in wet conditions on account of electric shock may be caused.
7. Please do not block the ventilation or look at the LED light source directly when it is powered on. Please do not touch the LED light source in any condition.
8. When using the fixture for long periods of time in high temperature environments above 40°C / 104°F, care must be taken as burns can occur from touching hot surfaces.
9. Please do not place the unit near any flammable object.
10. Avoid rapid shaking or rotating of the light when moving the light stand to prevent damage to the amaran Ace Lock quick-release mount.
11. We recommend only using the original amaran power adapter and regular power bank accessories. Please note that any malfunctions caused by using unauthorized accessories are not covered by the warranty. The user may pay for maintenance.
12. This product is certified by RoHS inspection report. Please operate the product in full compliance with relevant country's standards. Any malfunctions caused by incorrect use are not covered by warranty. The user may pay for maintenance.
13. The instructions and information in this manual are based on thorough, controlled company testing procedures. Further notice will not be given if the design or specifications change.

FCC Compliance Statement

WARNING

Changes or modifications not expressly approved by the party responsible for compliance could void the user's authority to operate the equipment.

NOTICE

This equipment has been tested and found to comply with the limits for a Class B digital device, pursuant to Part 15 of the FCC Rules. These limits are designed to provide reasonable protection against harmful interference in a residential installation. This equipment generates, uses, and can radiate radio frequency energy and, if not installed and used in accordance with the instructions, may cause harmful interference to radio communications. However, there is no guarantee that interference will not occur in a particular installation.

If this equipment does cause harmful interference to radio or television reception, which can be determined by turning the equipment off and on, the user is encouraged to try reorient or relocate the receiving antenna.

- Increase the separation between the equipment and receiver.
- Connect the equipment to an outlet on a different circuit than the receiver is connected to.
- Consult the dealer or an experienced radio/TV technician for help.

RF Warning Statement

This device has been evaluated to meet general RF exposure requirements.

Disclaimer

Before using this product, please read the product manual to ensure correct use under the complete understanding. After reading, please keep the product manual properly for future reference. In case of not operating this product correctly, it may seriously harm yourself or others, or result in product damage and property loss. When using this product, it shall be deemed that you have understood, recognized and accepted all clauses and contents of this document. The user commits to be responsible for their own behaviors and all consequences thereof. amaran shall not be liable for any loss due to the user who does not use this product in accordance with the product manual.

Under the laws and regulations, our company holds the final explanation right of this document and all related documents of this product. No prior notice will be given for any update, revision or termination. Please visit the official amaran website for the latest product information.