

amaran[®]

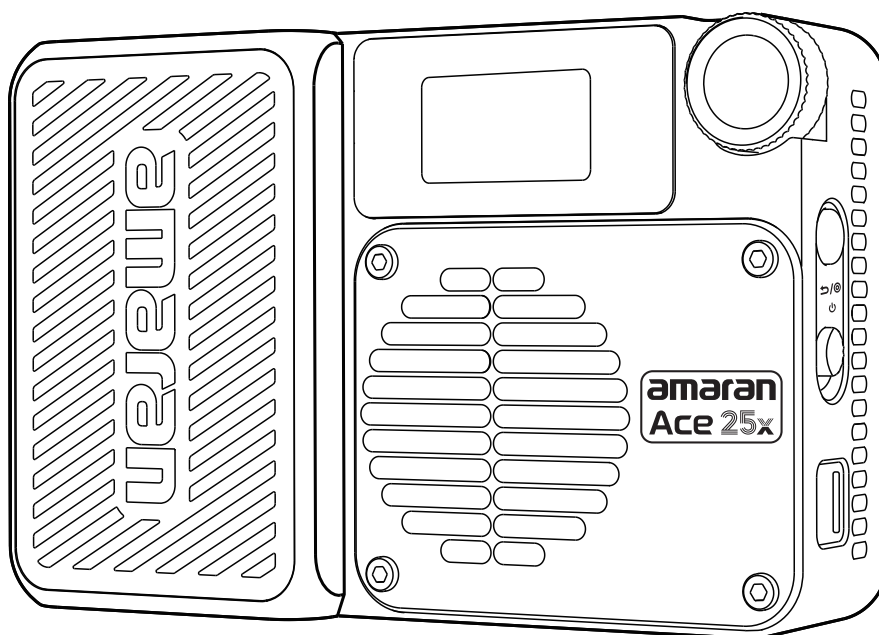

amaran Ace 25x

Product Manual

English

Table of Content

Introduction.....	03
Components List.....	04
Product Overview	06
Operations.....	08
1. Power On/Off.....	08
2. amaran Ace Lock Operation	08
3. Back Magnetic Silicone Pad Operation.....	10
4. Main Menu	10
4.1 CCT.....	11
4.2 FX.....	11
4.3 Bluetooth Reset	11
4.4 Custom Mode.....	12
4.5 Language.....	12
4.6 Output Mode	13
4.7 Boost Mode	13
4.8 Fan Mode	14
4.9 Firmware Upgrade	14
Using the amaran App.....	15
Specifications	16
Photometrics.....	17
Disclaimer.....	19
Important Safety Instructions.....	20
FCC Compliance Statement	22
RF Warning Statement.....	22

Introduction

Thank you for purchasing the amaran Ace 25x. Designed for on-the-go mobile creators, the amaran Ace 25x is a compact on-camera light with up to 32W of power output¹ and adjustable color temperature that can easily light up any space – from vlogging, livestreaming, to shooting live events. Featuring the amaran Ace Lock quick-release mount, you can create efficiently and securely by snapping the light onto a camera or a tripod² in less than a second. Its long battery life and fast charging speed also allow creators to create confidently knowing your content will be well-lit throughout your entire shoot. The amaran Ace 25x is a portable and versatile lighting tool that can adapt to any creative project on-the-go.

1. Boost mode allows you to increase power output from the standard 25W to 32W.

2. The amaran Ace Lock Mini Tripod is included in the Kit version or sold separately.

Components List

Please make sure all accessories listed below are completed before using. If not, please contact your sellers immediately.

amaran Ace 25x:

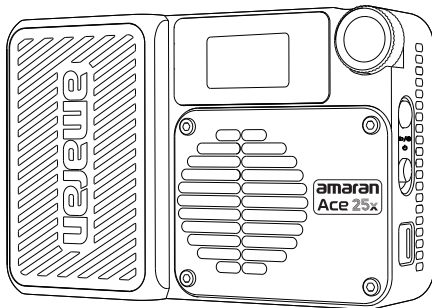

amaran Ace 25x x1

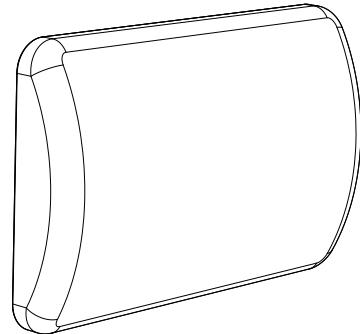

amaran Ace Dome Diffuser x1



5mm hex wrench x1

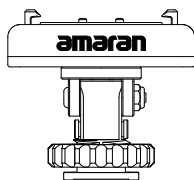

amaran Ace Lock to Cold Shoe Adapter x1

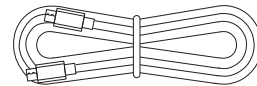

amaran USB-C Charging Cable x1

amaran Ace 25x Kit:

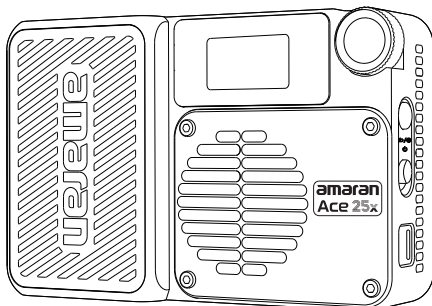

amaran Ace 25x x1

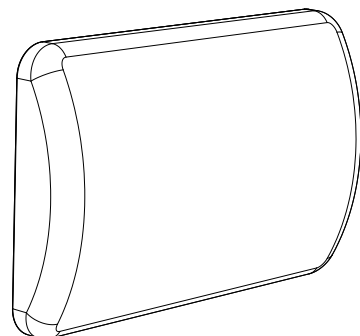

amaran Ace Dome Diffuser x1

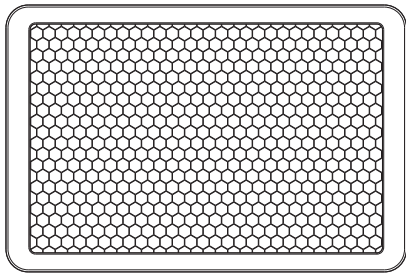

amaran Ace 30° Light Control Grid x1

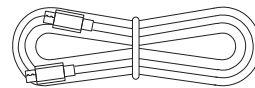

amaran USB-C Charging Cable x1



5mm hex wrench x1

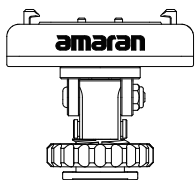

amaran Ace Lock to Cold Shoe Adapter x1

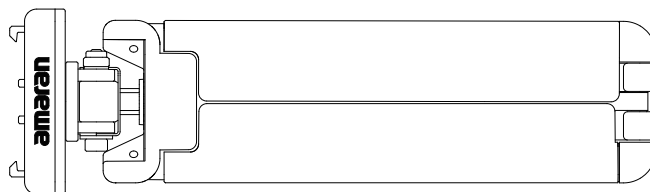

amaran Ace Lock Mini Tripod x1

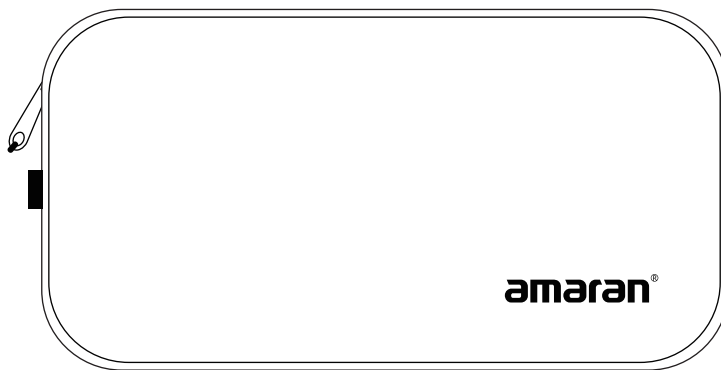

amaran Ace Carrying Case x1

Note: The illustrations in the manual are only diagrams for reference. Due to the continuous development of new versions of the product, if there are any differences between the product and the user manual diagrams, please refer to the product itself.

Product Overview

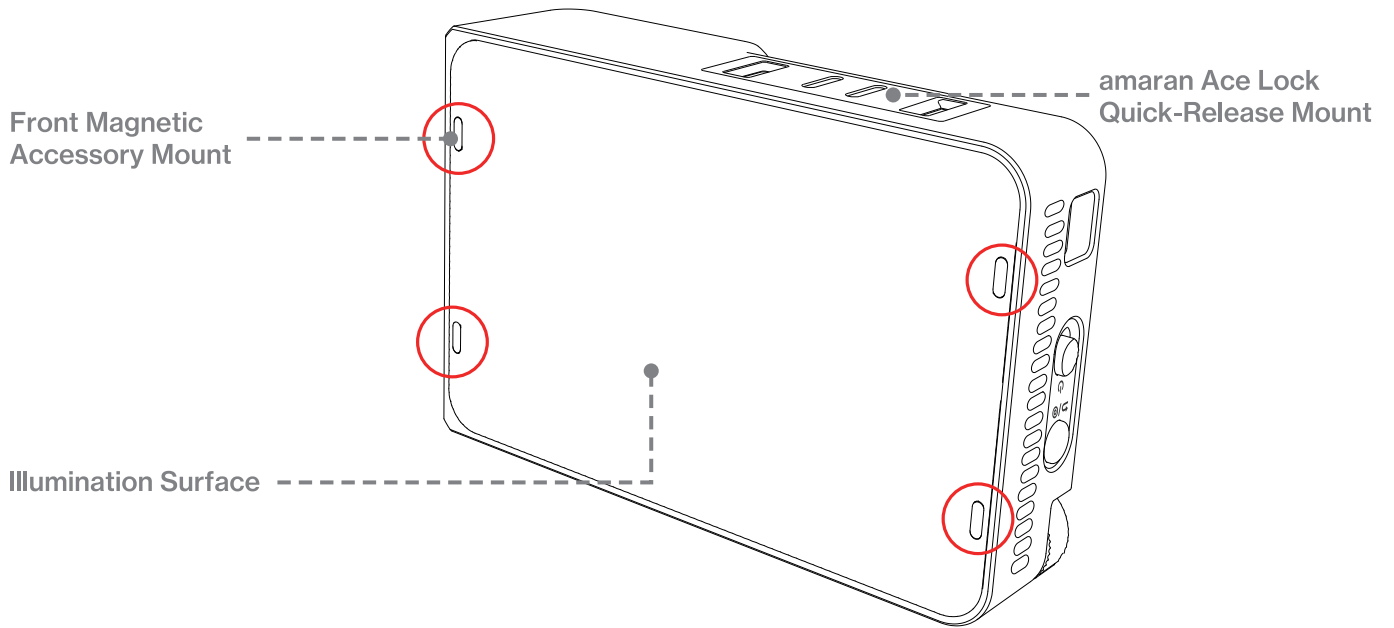
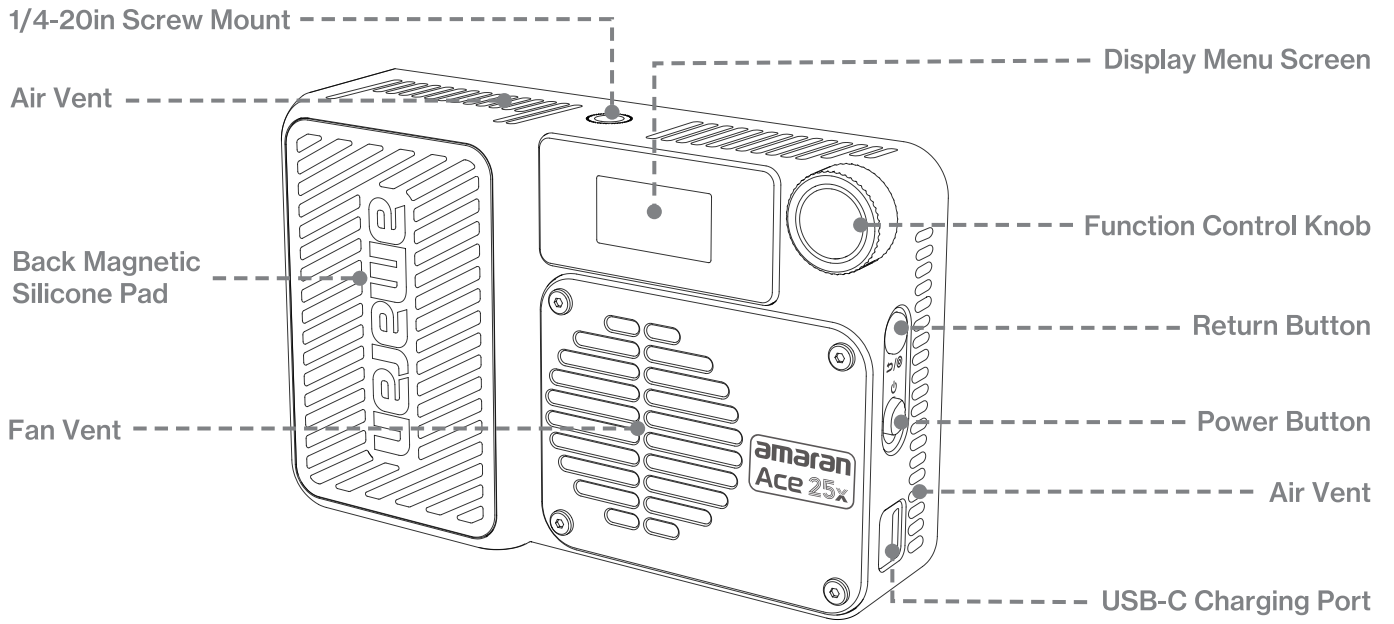

Display Menu Screen	Displays settings and status of your light.
Function Control Knob	Rotate to toggle the menu, adjust lighting settings, and confirm options.
Return Button	Click to return to the previous menu screen. Double click or long press shortcuts can be customized via the Custom menu.
Power Button	Press to turn on.
USB-C Charging Port	Used to charge the fixture and output power.
Fan Vent	Helps the light dissipate heat. Please do not block the fan vent when using the light.
Back Magnetic Silicone Pad	Attach your light to any magnetic surface.
Air Vent	The temperature of the air vent may be higher after long usage. Please do not block the air vent when using the light as it helps the light dissipate heat.
1/4-20in Screw Mount	Mount the light onto 1/4-20in tripods or other equipment, or to mount a microphone on top of the light.
amaran Ace Lock Quick-Release Mount	Install and disassemble the light in less than a second with the amaran Ace Lock ecosystem.
Front Magnetic Accessory Mount	Shape your light in seconds with included light control accessories.
Illumination Surface	The temperature of the illumination surface may be higher when the light is in use. Touch carefully.

Operations

1. Power On/Off

- ① Toggle the power button on the side of the fixture to turn the light on.
- ② You can select your preferred language when you turn the light on for the first time, Rotate the dial to select your language.
- ③ click to confirm.

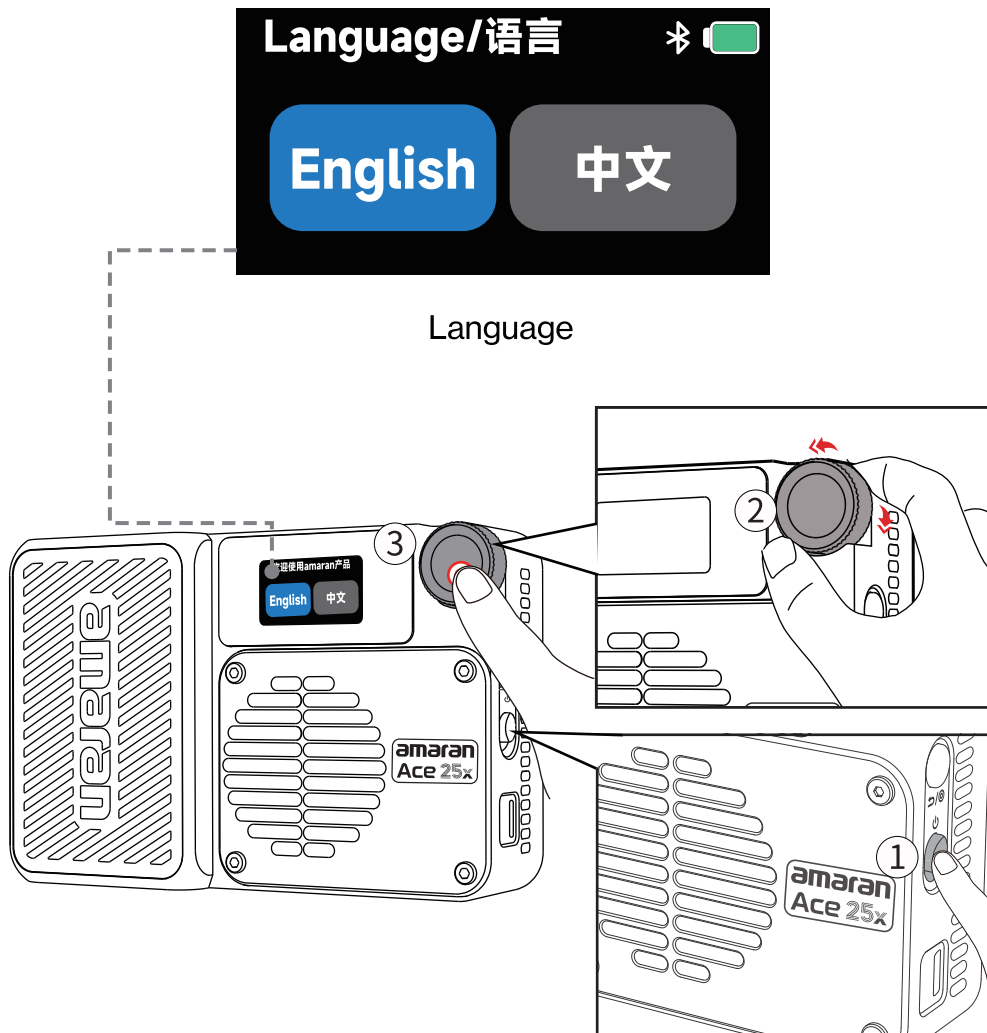

2. amaran Ace Lock Operation

The top section is designed for attaching the light fixture, while the bottom features a 1/4-inch screw hole for easy mounting on a light stand. Additionally, it comes with a cold shoe mount for installation on top of a camera. To use the cold shoe mount, first loosen the blue nut at the bottom, insert the Amaran Ace Lock cold shoe mount into the camera's cold shoe slot, then tighten the blue nut to secure the setup.

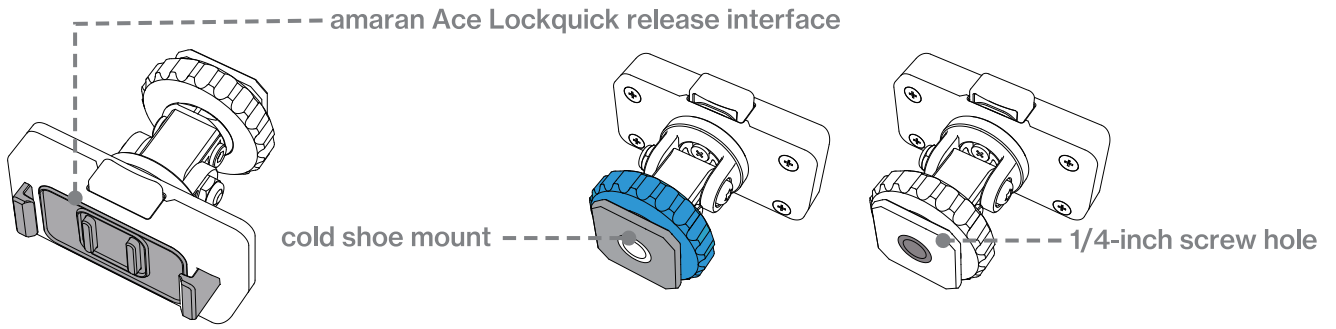

To install the amaran Ace Lock to Cold Shoe Adapter, press the blue release key and push towards the bottom of the light. The adapter is securely attached to the light when the pins are embedded into the amaran Ace Lock mount and when you hear a clicking noise.

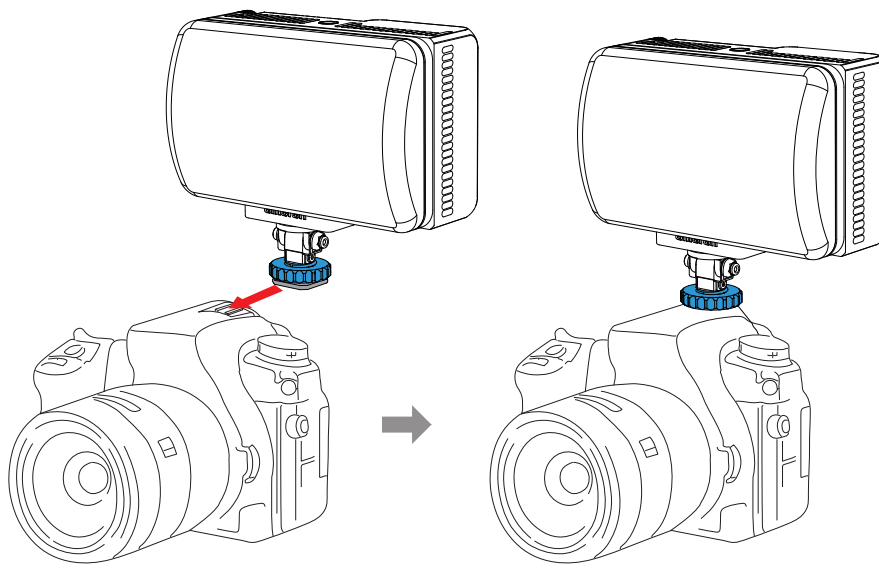

Connect camera

amaran Ace Lock Installation

To install the amaran Ace Lock to Cold Shoe Adapter, press the blue release key and push towards the bottom of the light. The adapter is securely attached to the light when the pins are embedded into the amaran Ace Lock mount and when you hear a clicking noise.

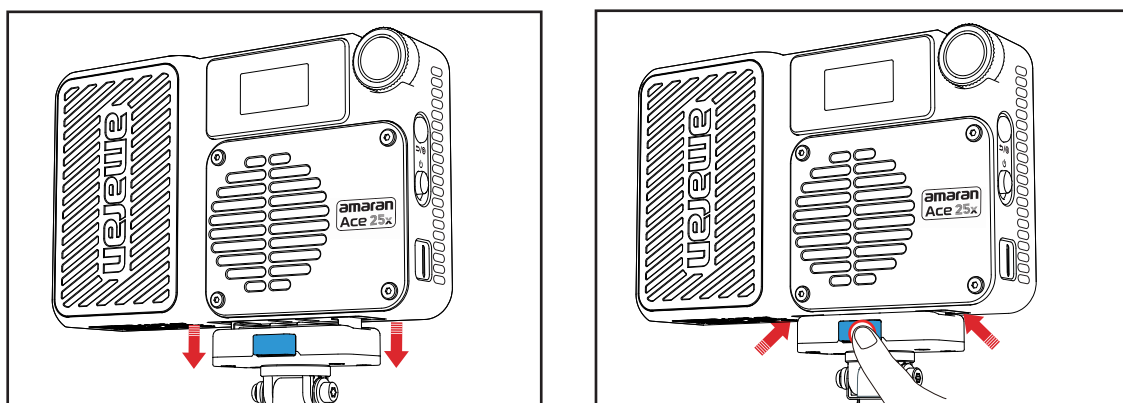

To disassemble, press the blue release key on the amaran Ace Lock to Cold Shoe Adapter and pull downwards away from the light.

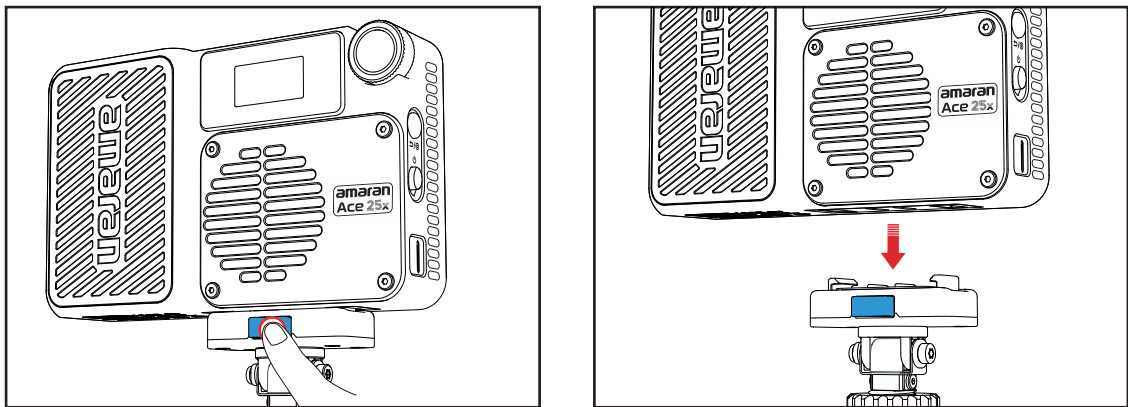

3. Back Magnetic Silicone Pad Operation

The silicone pad on the back of the amaran Ace 25c light has integrated magnets, allowing you to attach your light to any magnetic surface for easy or last minute mounting.

Note: When mounting the light via the back magnetic silicone pad, do not attach it to a magnetic surface with a surface temperature higher than 80°C / 176°F, otherwise the strength of the magnet may be greatly reduced.

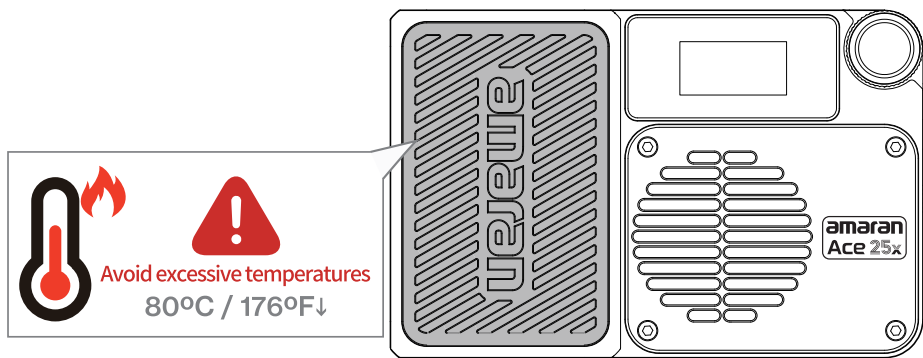

4. Main Menu

Rotate and press the knob to select light modes and settings.

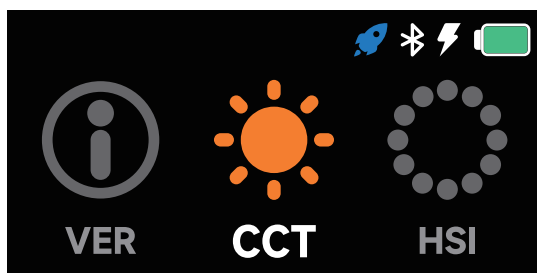

4.1 CCT

Rotate and press the knob to enter CCT mode from the main menu. In CCT, press the knob to select INT or CCT and rotate the dial to adjust the corresponding value.

- **INT (Intensity):** Adjust your light's brightness from 0%-100%.
- **CCT (Correlated Color Temperature):** Adjust your light's color temperature from warm white (2,700K CCT) to cool white (6,500K CCT).

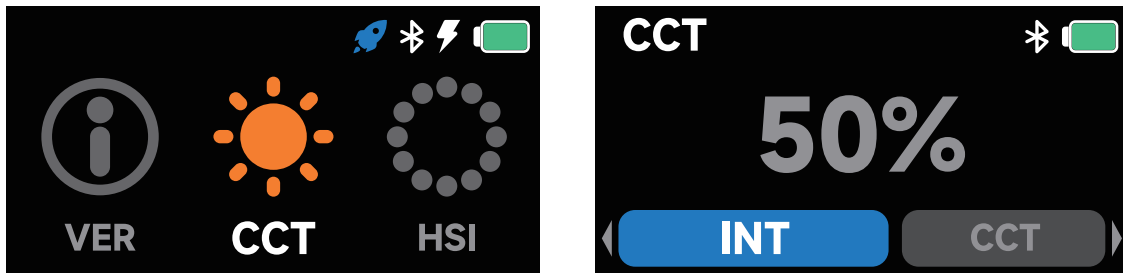

4.2 FX

Rotate and press the knob to enter FX mode from the main menu. In FX, rotate and press the knob to select your lighting effect. Press again to enter the settings and rotate the dial to adjust the corresponding value.

Supported lighting effects:

Fireworks	Faulty Bulb	Lightning	TV	Pulsing
Strobe	Explosion	Fire	Paparazzi	

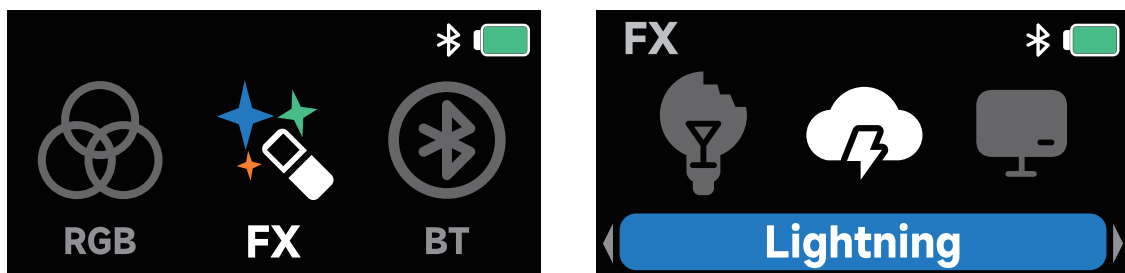

4.3 Bluetooth Reset

Rotate and press the knob to enter BT mode from the main menu. Long press the knob until the end of the progress bar. Release the knob to cancel.

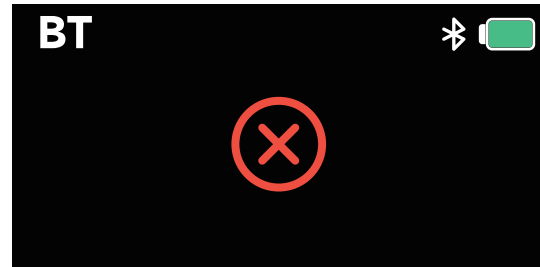
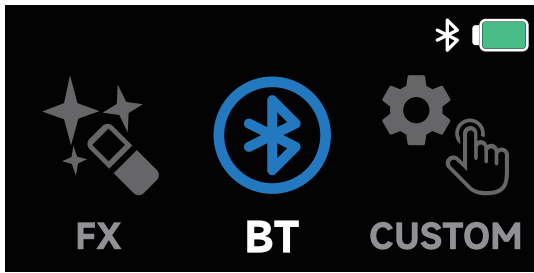

Bluetooth reset is successful.

Bluetooth reset is unsuccessful.
Please reset Bluetooth again.

4.4 Custom Mode

Rotate and press the knob to enter Custom mode from the main menu. In Custom mode, press the knob to select customizable shortcuts for long press (Hold) or double click (Double) of the return button. Rotate the dial to select between SOS/BT Reset/CCT/FX/Rotation/Boost short-cut functions. Short press of the return button defaults to the return/back function and cannot be changed.

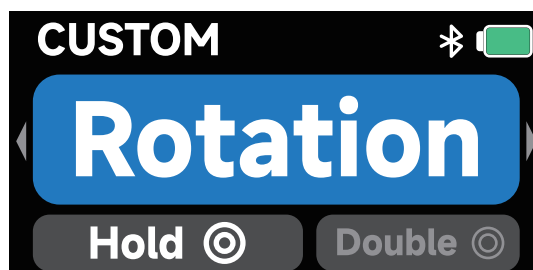
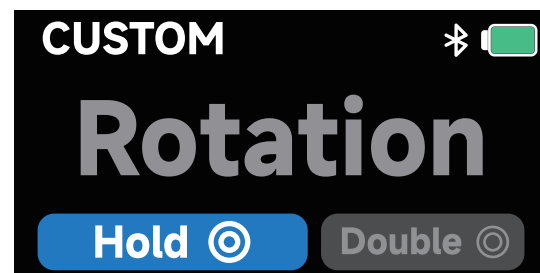
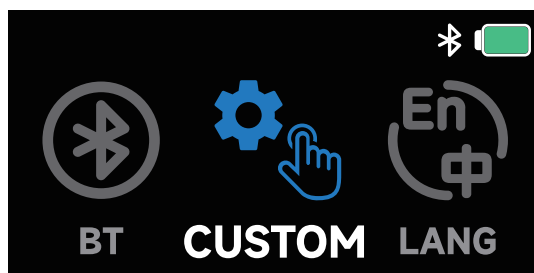

4.5 Language

Rotate and press the knob to enter Language settings from the main menu. In Language, rotate the dial to toggle between English or Chinese. Press the knob to confirm your language.



4.6 Output Mode

The amaran Ace 25x has a reverse power output capability to act as a reverse power supply to keep your other equipment running in emergency power situations, including other compact lights, camera equipment, or mobile phones. The maximum DC charging output is 5V/2A.

Rotate and press the knob to enter Output mode from the main menu. In Output, rotate the dial to toggle between On or Off. Press the knob to confirm your settings.

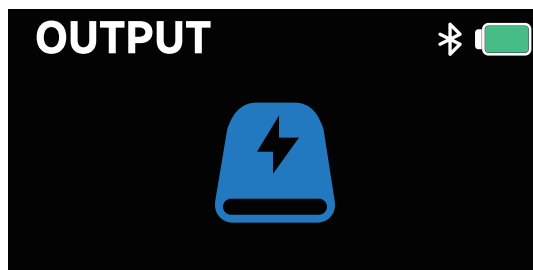
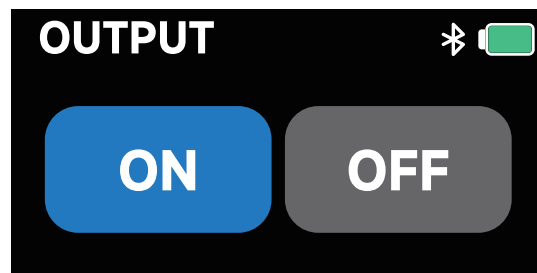
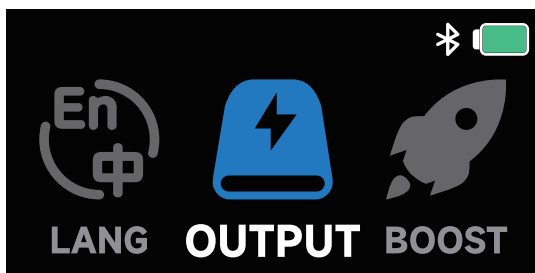

Note: Once in the power output mode, the light will remain on the Output interface and cannot be used to output light. Press the return button to exit the Output mode and stop the reverse power output function.

4.7 Boost Mode

Rotate and press the knob to enter Boost mode from the main menu. In Boost, rotate the dial to toggle between On or Off. Press the knob to confirm your settings. When in Boost mode, the maximum power output will be increased from the standard 25W to 32W and can be used for long durations* without damage to the light fixture.

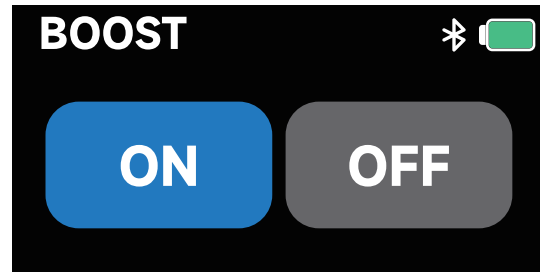
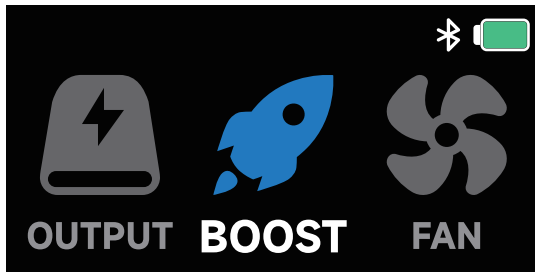

Note: The fan noise of the light when in Boost mode will be slightly higher than in normal mode.

* The data was measured at an ambient temperature of 40°C / 104°F. Boost mode can be used for long periods within an ambient temperature of 40°C / 104°F.

4.8 Fan Mode

Rotate and press the knob to enter Fan mode from the main menu. In Fan mode, rotate the dial to toggle between Silent and Smart fan mode. Press the knob to confirm your settings.

- **Silent Mode:** The fan will be completely turned off, and the light will not produce any noise. The power output will be limited to 6.5W and can be operated for 4 hours 40 minutes at maximum brightness.
- **Smart Mode:** The fan speed will automatically adjust according to the temperature of the light.

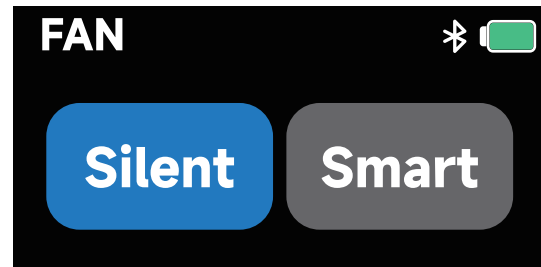

4.9 Firmware Upgrade

Firmware updates can be updated online via the amaran app.

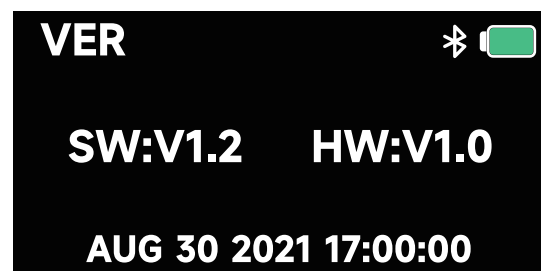

Using the amaran App

You can download the amaran mobile app from the iOS App Store, Google Play Store, and other platforms for enhancing the functionality of the light. You can download the amaran desktop app from the amaran website. Please visit amarancreators.com for more details regarding how to use the app to control your amaran lights.



Scan the QR code to download the amaran app

Specifications

Power Input	41W (Max)	Power Output	32W (Max)
CCT	2700-6500K	Lumens	3414lm
CRI	95+	TLCI	95+
TM-30 Rg (Average)	102	TM-30 Rf (Average)	94
SSI (D32)	83	SSI (D56)	73
CQS	94	Power supply specifications	PD/QC
Operating Temperature	-10°C-40°C	Storage Temperature	-20°C-80°C
Control Methods	Manual, amaran@App	Firmware upgrade method	amaran App
Screen Type	TFT	Remote control distance (Bluetooth)	≤80m
Charge Time	1h30min	Cooling method	Active Cooling
Battery Capacity	33.3Wh/4500mAh	Battery voltage	7.4V
Battery Life Boost Mode (32W)	50min	Battery Life Standard Mode (25W)	1h10min
Battery Life Silent Mode (6.5W)	4h40min	USB-C Cable	50cm
Fixture Dimensions	118*77*33mm	Fixture Weight	325.5g
Dome Diffuser Dimensions	117*76.5*19mm	Dome Diffuser Weight	32.5g
Mini Tripod Dimensions	Storage: 158*45.5*23mm Extend: 327*45.5*23mm	Mini Tripod Weight	233.4g
Carrying Case Dimensions	187*93*93mm	Carrying Case Weight	115.5g

Photometrics

Standard Mode				
CCT	Distance	Bare Bulb	Dome Diffuser	Light Control Grid
2700K	0.5m	4760Lux	1668Lux	3970Lux
		442fc	155fc	369fc
	1m	1227Lux	421Lux	896Lux
		114fc	40fc	83fc
3200K	0.5m	4860Lux	1732Lux	4070Lux
		452fc	161fc	378fc
	1m	1254Lux	918Lux	435Lux
		117fc	85fc	40fc
4300K	0.5m	4990Lux	1799Lux	4180Lux
		464fc	167fc	388fc
	1m	1287Lux	455Lux	940Lux
		120fc	42fc	87fc
5600K	0.5m	5230Lux	1910Lux	4350Lux
		486fc	177fc	404fc
	1m	1346Lux	482Lux	979Lux
		125fc	45fc	91fc
6500K	0.5m	5320Lux	1962Lux	4460Lux
		494fc	182fc	414fc
	1m	1379Lux	494Lux	997Lux
		128fc	46fc	93fc

Boost Mode				
CCT	Distance	Bare Bulb	Dome Diffuser	Light Control Grid
2700K	0.5m	5010Lux	1746Lux	4010Lux
		465fc	162fc	373fc
	1m	1301Lux	441Lux	994Lux
		121fc	41fc	92fc
3200K	0.5m	5880Lux	2077Lux	4860Lux
		546fc	193fc	452fc
	1m	1526Lux	524Lux	1170Lux
		142fc	49fc	109fc
4300K	0.5m	6010Lux	2163Lux	5000Lux
		558fc	201fc	465fc
	1m	1563Lux	547Lux	1206Lux
		145fc	51fc	112fc
5600K	0.5m	6320Lux	2293Lux	5260Lux
		587fc	213fc	489fc
	1m	1636Lux	580Lux	1253Lux
		152fc	54fc	116fc
6500K	0.5m	5960Lux	2183Lux	4650Lux
		554fc	203fc	432fc
	1m	1544Lux	552Lux	1188Lux
		143fc	51fc	110fc

Disclaimer

Before using this product, please read the product manual to ensure correct use under the complete understanding. After reading, please keep the product manual properly for future reference. In case of not operating this product correctly, it may seriously harm yourself or others, or result in product damage and property loss. When using this product, it shall be deemed that you have understood, recognized and accepted all clauses and contents of this document. The user commits to be responsible for their own behaviors and all consequences thereof. Aputure shall not be liable for any loss due to the user who does not use this product in accordance with the product manual.

Under the laws and regulations, our company holds the final explanation right of this document and all related documents of this product. No prior notice will be given for any update, revision or termination. Please visit the official Aputure website for the latest product information.

Important Safety Instructions

When using the amaran Ace 25x, basic safety precautions should always be followed, including the following:

1. Read and understand all instructions before using.
2. Close supervision is necessary when any fixture is used by or near children. Do not leave the fixture unattended while in use.
3. Care must be taken as burns can occur from touching hot surfaces.
4. Do not operate the fixture if a cord is damaged, or if the fixture has been dropped or damaged, until it has been examined by qualified service personnel.
5. Always unplug the USB-C Charging Cable from the power outlet before cleaning and servicing, or when not in use. Never yank the cord to remove the plug from the outlet.
6. Let the unit cool completely before storing. Unplug the power cable from the fixture before storing, and store the cable in the assigned space of the carrying pouch.
7. To reduce the risk of electric shock, do not immerse this fixture in water or any other liquids.
8. To reduce the risk of fire or electric shock, do not disassemble this fixture. Contact amaran Customer Support or take the fixture to qualified service personnel when service or repair is required. Incorrect reassembly may cause electric shock when the fixture is in use.
9. The use of any accessory attachment not recommended by the manufacturer may increase the risk of fire, electric shock, or injury to any persons operating the fixture.
10. Please do not block the ventilation or look at the LED light source directly when it is powered on. Please do not touch the LED light source in any condition.
11. Please do not place the unit near any flammable object.
12. Only use a dry microfiber cloth to clean the product.
13. Please do not use the light fixture in wet condition on account of electric shock may be caused.
14. Please have the product checked by an authorized service personnel agent if the product has a problem. Any malfunctions caused by unauthorized disassembly are not covered by the warranty. The user may pay for maintenance.
15. We recommend only using the original amaran cable accessories. Please note that any malfunctions caused by using unauthorized accessories are not covered by the warranty. The user may pay for maintenance.

16.This product is certified by ROHS, inspection report. Please operate the product in full compliance with relevant country's standards. Any malfunctions caused by incorrect use are not covered by warranty. The user may pay for maintenance.

17.The instructions and information in this manual are based on thorough, controlled company testing procedures. Further notice will not be given if the design or specifications change.

SAVE THESE INSTRUCTIONS

FCC Compliance Statement

WARNING

Changes or modifications not expressly approved by the party responsible for compliance could void the user's authority to operate the equipment.

NOTICE

This equipment has been tested and found to comply with the limits for a Class B digital device, pursuant to Part 15 of the FCC Rules. These limits are designed to provide reasonable protection against harmful interference in a residential installation. This equipment generates, uses, and can radiate radio frequency energy and, if not installed and used in accordance with the instructions, may cause harmful interference to radio communications. However, there is no guarantee that interference will not occur in a particular installation.

If this equipment does cause harmful interference to radio or television reception, which can be determined by turning the equipment off and on, the user is encouraged to try reorient or relocate the receiving antenna.

- Increase the separation between the equipment and receiver.
- Connect the equipment to an outlet on a different circuit than the receiver is connected to.
- Consult the dealer or an experienced radio/TV technician for help.

RF Warning Statement

This device has been evaluated to meet general RF exposure requirements.